

600MM MULTIFUNCTION OVENS

Models: - IOB6SE1
 IOF6SE4
 IOE6SE1

 **HOME APPLIANCES**

distributors of
Euromaid IAG & ARC

Installation and Operation manual

USER INSTRUCTIONS

SPECIAL NOTE

This Installation and Operation Manual is utilised for many different models throughout the world and not all the instructions or features covered within this manual will relate to your specific model.

GENERAL WARNINGS

Read carefully all the instructions contained in this booklet. It provides you with important information regarding the safe installation, use and maintenance of the appliance as well as useful advice for getting the best out of your oven. Keep this booklet in a safe place for future reference. After removing the packing, check that the appliance is not damaged in any way.

Be careful not to leave the packing materials (plastic sheeting, expanded polystyrene etc.) where children can get at them, as they can be dangerous.

- The appliance is not intended for use by persons (including children) with reduced physical, sensory or mental capabilities, or lack of experience and knowledge, unless they have been given supervised or instruction concerning use of the appliance by a responsible person for their safety.
- Young children should be supervised to ensure that they do not play with the appliance.
- **WARNING:** Accessible parts may become hot during use. To avoid burns young children should be kept away
- If the supply cord is damaged, it must be replaced by the manufacturer or its service agent or a similarly qualified person in order to avoid a hazard.
- During use the appliance becomes hot. Care should be taken to avoid touching heating elements inside the oven. Please keep children away from the oven.
- **WARNING:** Ensure the appliance is switched off before replacing the lamp to avoid the possibility of electric shock.
- Do not use harsh abrasive cleaners or sharp metal scrapers to clean the oven door since they can scratch the surface, which may result in shattering of the glass.
- Do not use a steam cleaner to clean the oven.
- If the range is not fitted with a flexible cord, the instruction manual must clearly state the type and size of cord to be used.

IMPORTANT: do not use the oven door handle to move the appliance, such as to remove it from the packaging

ATTENTION

The oven is an appliance which, for its nature, becomes hot, especially in correspondence of the glass door.

It is therefore a good rule that children do not approach the oven when it is functioning, particularly when the grill is used.

The first time you switch the oven on, acrid smelling smoke may appear. This is caused by the heating of the adhesive used on the insulation panels surrounding the oven. There is nothing unusual about this. If it happens, simply wait until the smoke disappears before putting any food in the oven. Never roast or bake on the oven base, **nor should any kind of drip tray or aluminium foil be placed on the base of the oven as damage to ENAMEL could occur.**

Safety is a good habit to get into

- ⦿ This appliance is designed for non-professional, household use and its functions must not be changed.
- ⦿ The electrical system of this appliance may be used safely only when it is correctly connected to an efficient earthing system in compliance with the safety standards currently in effect.
- ⦿ The manufacturer will not be held liable for any damages that might arise out of incorrect installation or improper, incorrect or unreasonable use of the appliance.

The following items are potentially dangerous, and therefore, appropriate measures must be taken to prevent children and the disabled from coming into contact with them:

- Controls and the appliance in general;
- Packaging (bags, polystyrene, nails, etc.);
- The appliance immediately after use of the oven or grill due to the heat generated;
- The appliance when no longer in use (potentially dangerous parts must be made safe).

Avoid the following:

- Touching the appliance with wet parts of the body;
- Using the appliance when barefoot;
- Pulling on the appliance or the supply cord to unplug it from the electrical outlet;
- Obstructing the ventilation or heat dissipation slots;
- Allowing power supply cords for small appliances to come into contact with the hot parts of the appliance;
- Exposing the appliance to atmospheric agents (rain, sun);
- Using the oven for storage purposes;
- Using flammable liquids near the appliance;
- Using adaptors, multiple sockets and/or extension cords;
- Attempting to install or repair the appliance without the assistance of qualified personnel.

WARNING- Accessible parts will become hot when in use. To avoid burns and scalds children should be kept away

During use the appliance becomes hot, Care should be taken to avoid touching heating elements inside the oven.

Qualified personnel must be contacted in the following cases:

- Installation (following the manufacture's instructions);
- When in doubt about operating the appliance;
- Replacing the electrical outlet when it is not compatible with the plug for the appliance.

Service Centres authorized by the manufacturer must be contacted in the following cases:

- If in doubt about the soundness of the appliance after removing it from the packaging;
- If the power supply cord has been damaged or needs to be replaced;
- If the appliance breaks down or functions poorly; ask for original spare parts.

It is a good idea to do as the following:

- Only use the appliance to cook food, nothing else;
- Check the soundness of the appliance after it has been unpacked;
- Unplugged the appliance from the electrical mains if it is not functioning properly and before cleaning or performing maintenance;
- When the appliance is not used for an extended period of time, unplugged the appliance and close the gas cock (if present);
- Use cooking gloves to place cookware in the oven or when removing it;
- Always grasp the oven door in the centre because the ends may be hot due to the escape of hot air;
- Make sure that the control knobs are on the "o" setting when the appliance is not in use;
- Unplug the appliance when you decide not to use the appliance any longer.

© The manufacturer may not be held responsible for any damage due to: incorrect installation, improper, incorrect and irrational use.

SPECIFICATION

The ovens are designed to operate with a monophase alternating current of 220-240V 50Hz. anyway, before the installation of the appliance, we suggest you to check always these specifications on the rating label applied on the outside rear part.

Powers absorbed in accordance with models

		Accessories according to models	
Oven lower heating el. 1200Watt	Oven inside heating el. 1900 Watt	synchromotor	4 Watt
Oven upper heating el. 1000Watt	Total grill heating el. 1000+1900 Watt	Shaded motor (back)	25 Watt
Oven light 15Watt	Circle heating el. 2100Watt	Shaded motor (top)	15Watt

Overall dimensions for oven volume: width 436mm-height 315mm-depth 410mm=56liters

INDICATOR LIGHTS

The indicator lights situated above the control panel go on and off when the heating elements are inserted or removed. During the thermostatic functioning of the oven, the neon light remains on until the pre-chosen temperature is reached and when it goes out, this is a sign that the temperature has been reached. When the oven cools, the thermostat determines the re-insertion of the heating elements with consequent re-lighting of the indicator lights. In models the internal oven light, which is always on when any function is in operation, is considered as an operation, is considered as an operating warning light.

INSTALLING THE APPLIANCE

Important: Unplug your oven before performing installation or maintenance!

Installation should be carried out according to the instructions by a professionally qualified person.

The manufacturer declines all responsibility for any damage to persons, animals or things due to a wrong installation.

FITTING THE APPLIANCE

Fit the appliance into its surround (beneath a work-top or above another appliance) by inserting screws into the 4 holes that can be seen in the frame of the oven when the door is open.

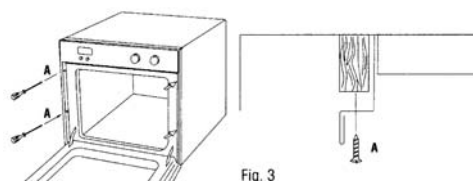

Fig. 3

For the most efficient air circulation, the oven should be fitted according to the dimensions shown in fig. 1-2 of page 2.

The rear panel of the cabinet must be removed so that air can circulate freely. The panel to which the oven is fitted should have a gap of at least 70 mm at the rear.

NB: where ovens are to be matched with hobs, it is essential to follow the instructions contained in the booklet supplied with the other appliance.

IMPOTANT

During use the appliance becomes hot, Care should be taken to avoid touching heating elements inside the oven.

Accessible parts may become hot during use. Yong children should be kept away.

Do not use harsh abrasive cleaners or sharp metal scrapers to clean the oven door glass since they can scratch the surface, which may result in shattering of the glass.

For a built-in oven to work well the cabinet must be of the right type.

The panels of the adjoining furniture should be heat resistant. Particularly when the adjoining furniture is made of veneered wood, the adhesives should be able to withstand a temperature of 120°C. Plastic materials or adhesive which cannot withstand this temperature will become deformed or unstuck.

To comply with safety regulations, once the appliance has been fitted it should not be possible to make contact with the electrical parts.

All parts which offer protection should be fixed in such a way that they cannot be removed without the use of a tool.

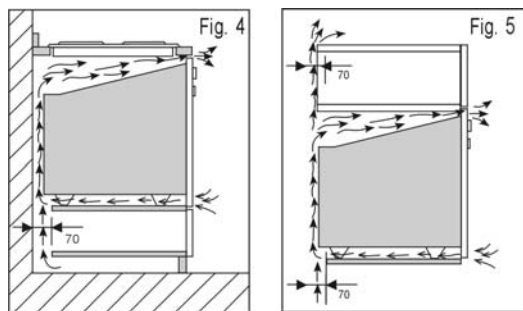

Ensure that the appliance is switched off before replacing the lamp to avoid the possibility of electric shock.

CONNECTION TO THE MAINS SUPPLY

THE APPLIANCE MUST BE CONNECTED ACCORDANCE WITH THE RULES CURRENTLY.

IN FORCE, AND ONLY BY AN AUTHORIZED ELECTRICAL INSTALLER.

WARNING: THIS APPLIANCE MUST BE EARTHED

Check that the power rating of the mains supply and of the sockets are suitable for the maximum power of the appliance as indicated on the specification plate.

plug should be accessible after installation. Fit the plug into a socket fitted with a third contact which corresponds with the earth connection. This should be properly connected.

If the appliance just fitted with supply leads but does not come already fitted with a plug, then permanently connect to fixed wiring as follow:

The "yellow/green" earth wire, which must be connected to terminal, has to be about 10mm longer than the other wires; the "blue" neutral wire has to be connected to the terminal marked with letter N.

"Black, brown, red" live wires have to be connected to terminal L. Mains connection can also be made by fitting a double pole switch with a minimum gap between the contacts of 3mm, proportionate to the load and complying with the regulations in force.

The yellow/green earth wire should not be controlled by the switch.

The plug or a double pole switch used for mains supply connection should be easy to get at, once the appliance is in position.

Important: position the mains supply cable so that it is never subjected to a temperature which is more than 50°C above ambient temperature.

The electrical safety of the appliance can only be guaranteed when it has been correctly connected to an efficient earthed power supply, as laid down in the regulations for electrical safety.

Important: the manufacturer cannot be held responsible for any damage to persons or objects due to lack of an earth connection.

GB

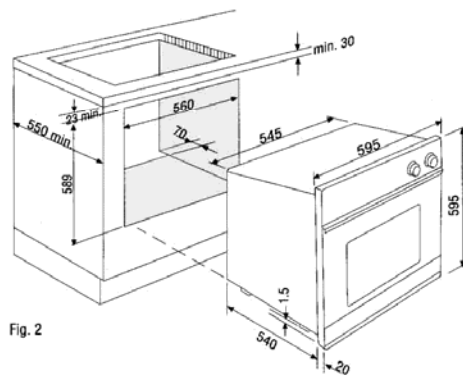
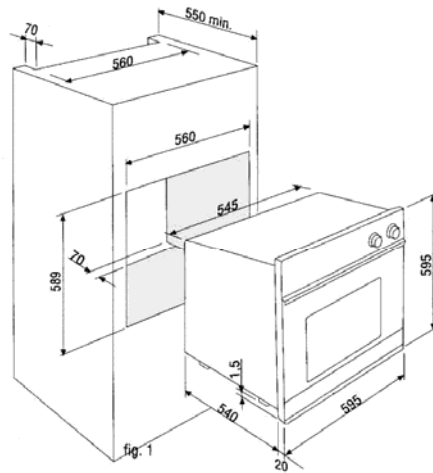

FITTING DIMENSIONS
 General tolerance for fitting dimension:
 Width: 560 \pm 1,5 mm
 Height: 589 \pm 0-2,5 mm



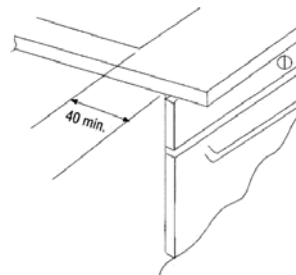





N.B.: ENCASTREMENT POUR PLAQUES A GAZ MOD. (...32..P.....) POLYVALENTES
N.B.: BUILDING-IN FOR GAS HOBS MOD. (...32..P.....) POLYVALENTES

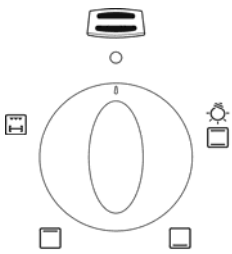
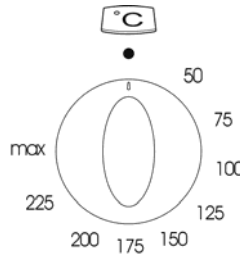

INSTRUCTIONS FOR USE: to switch off the oven, turn the knobs on position







(○) and (●)

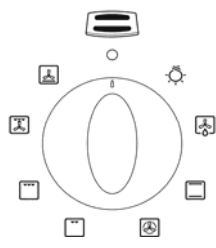
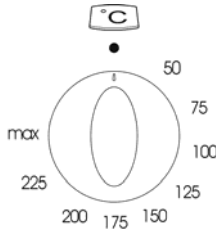
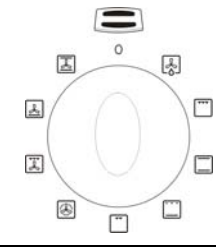
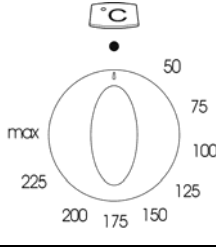

CONVECTIONAL OVENS 4 FUNCTIONS

 <p>SELECTOR KNOB</p>	 <p>THERMOSTAT</p>	<p>N.B.: All functions will start after selecting the temperature with the thermostat knob.</p> <p>The oven is fitted with:</p> <ul style="list-style-type: none"> ● a lower heating element; ● an upper heating element, which according to the cooking mode can be used for grilling or baking.
	<p>50 - MAX</p>	<p>When you turn the control knob to position  the light will be on for all the following operations.</p> <p>Natural convection</p> <p>Both the lower and upper heating elements operate together.</p> <p>This is the traditional cooking, very good for roasting joints, ideal for biscuits baked apples and crisping food. You obtain very good results when cooking on a shelf adjusting the temperature between 50 and MAX°C</p>
	<p>50 - MAX</p>	<p>Lower heating element</p> <p>This function is particularly indicated for cooking from the bottom, warming up food or sterilizing glass jars. It is also indicated for food requiring long and slow cooking, i.e. casserole.</p> <p>This function can be used between 50 and MAX°C.</p>
	<p>50 - MAX</p>	<p>Upper heating element</p> <p>It is indicated for warming up pre-cooked food when placing the grid on the second shelf from the top, or for defrosting pastry placing the grid on the first shelf from the bottom. This function can be used between 50 and MAX°C.</p>
	<p>50 - MAX</p>	<p>Total grill heating element  or (turnspit motor  according to the models, see Fig. 11-12).</p> <p>It is indicated for cooking on the spit, grilling and gratinating.</p> <p>This function can be used with closed door.</p>

MULTIFUNCTIONAL OVENS 8 FUNCTIONS

N.B.: All functions will start after selecting the temperature with the thermostat knob.

 <p>SELECTOR KNOB</p>	 <p>THERMOSTAT</p>	<p>N.B.: All functions will start after selecting the oven temperature with the thermostat knob.</p> <p>The oven is fitted with:</p> <ul style="list-style-type: none"> ● a lower heating element; ● an upper heating element, which according to the cooking mode can be used for grilling or baking. ● A circular heating element, which surrounds the fan.
		<p>N.B.: All functions will start after selecting the oven temperature with the thermostat knob.</p>
	<p>50 - MAX</p>	<p>Defrosting with fan</p> <p>The air at ambient temperature is distributed inside the oven for defrosting food more quickly and without proteins adulteration.</p>
	<p>50 - MAX</p>	<p>Natural convection</p> <p>Both the lower and upper heating elements operate together.</p> <p>This is the traditional cooking, very good for roasting joints, ideal for biscuits baked apples and crisping food. You obtain very good results when cooking on a shelf adjusting the temperature between 50 and MAX°C</p>
	<p>50 - MAX</p>	<p>Fan oven</p> <p>Both the fan and the circular heating element operate together. The hot air adjustable between 50 and MAX°C is evenly distributed inside the oven. This is ideal for cooking several types of food (meat, fish) at the same time without affecting taste and smell. It is indicated for delicate pastries.</p>
	<p>50 - MAX</p>	<p>Medium grill</p> <p>Used for grilling and gratinating small quantities of traditional food. This function can be used with closed door.</p>
	<p>50 - MAX</p>	<p>Total grill</p> <p>Used for grilling and gratinating traditional food in larger quantities. This function can be used with closed door.</p>

	<p>50 - MAX</p>	<p>Fan assisted total grill The air which is heated by the grill heating element is circulated by the fan and so helps to distribute the heat between 50 and 200°C. This function can be used for sterilizing glass jars.</p>
	<p>50 - MAX</p>	<p>Lower heating element + fan The air which is heated by the lower heating element is circulated by the fan and so helps to distribute the heat between 50 and 200°C. This function can be used for sterilizing glass jars.</p>
	<p>50 - MAX</p>	<p>upper heating and inside heating Series + lower heating element This function Used multibarreled has also worked, in the gallbladder gave off heat evenly, the enrgy consumption was low</p>

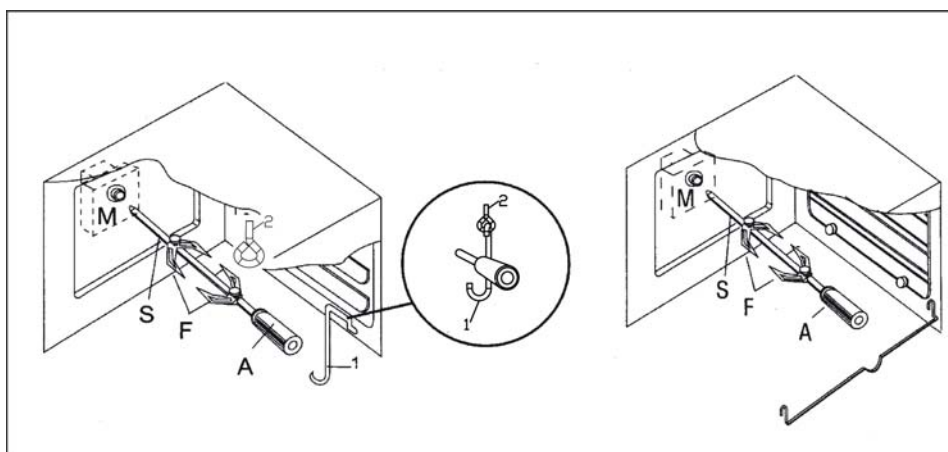





Fig.6

Fig.7

Using the turnspit (NOT AVAILABLE ON ALL MODELS)

In the "CONVECTIONAL OVEN" models, the turnspit can be used in combination with the grill. After fitting the food on to the spit S, block it with the two forks F. then proceed as follows:

- Fit the knobs protection as shown in (fig. 6)
- Position the spit support as shown in (fig.7)
- Fit the end of the spit into the motor M at the back of the oven (fig. 7).
- Fit the support into the circular groove in the spit.
- Unscrew and remove handle A.
- Place the oven tray with a little water on the lowest shelf of the oven.
- Turn the knob to position  or  or  or  to start up the motor.
- Partially close the oven door (fig. 6b).
- When the cooking time is up, screw the handle on the spit and remove everything from the oven. If necessary, use an oven glove to avoid any burn.

INSTRUCTIONS FOR USE OF CONTROL DEVICES

Timers

Our ovens can be fitted with different types of timers:

MINUTES COUNTERS

Turn the knob clockwise to set the desired cooking time.

The minutes minder can be adjusted from 1 to 60 minutes (Fig. 8) or 1 to 120 minutes (Fig. 9)

A sound signal will inform you that the chosen time is up.

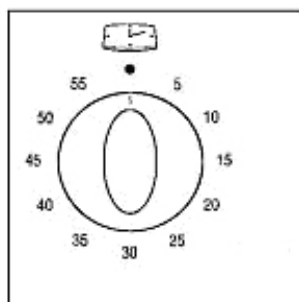

Fig.8

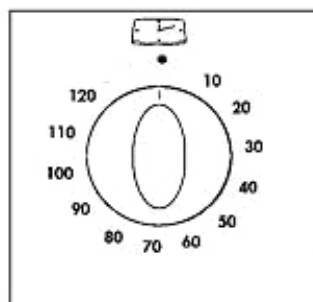

Fig.9

Operating instructions for Electronic Timer (6 keys)

<<LED>>PROGRAMMER (fig.10)

Features

24 hours clock with automatic programme and minutes counter

Functions

Cooking time, cooking end time, manual position, clock, minutes counter, times to be set up to 23 hours 59 minutes.

Display

4-figures, 7segments display for cooking times and time of day.

Cooking time and manual function =saucepan symbol

Automatic function =AUTO

Minutes counter =bell symbol

The symbols light up when the corresponding function are selected

Setting

To set ,press and release the desired function ,and within 5 seconds set the time with +and -buttons .

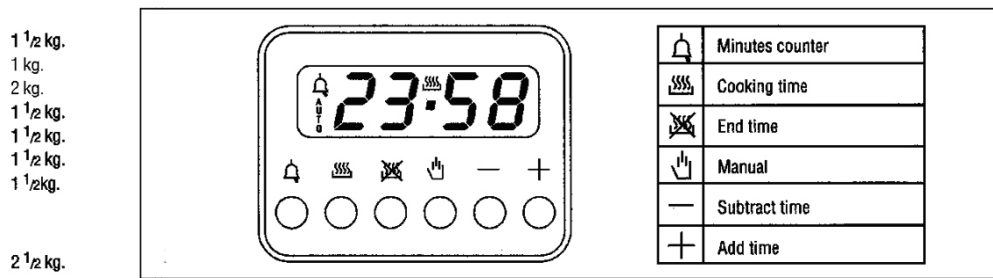

Fig.10

Tasto +e-

+and buttons .

the +and –buttons increase or decrease the time at a speed depending on how long button is pressed

Setting the time

press any two buttons (cooking time ,end time ,minutes counter) at the same time ,and +or –button to set the desired time .this deletes any previously set programme.

The contacts are switched off and the AUTO symbol flashes.

Manual use

By pressing the manual button the relay contacts switch on, the AUTO symbol switches off and saucupan symbol lights up.

Manual operation can only be enabled after the automatic programme is over or it has been cancelled.

Automatic use

Press the cooking time or end time button to automatically form the manual to the automatic function.

Semi-automatic use with cooking time setting

Press the cooking time button and set the desired time with +or -, the AUTO and cooking time symbols light up continuously. The relay switches on immediately. When the cooking end time corresponds to the time of day, the relay and the cooking time symbol switch off. the sound signal rings and the AUTO symbol flashes.

Semi-automatic use with end time setting

Press the end time button. The time of day appears on the display. Set the cooking end time with +button. The AUTO and cooking time symbols light up continuously. The relay contacts switch on. When the cooking end time corresponds to the time of day , the relay and the cooking time symbol switch off. When the cooking time is up. The AUTO symbol flashes, the sound signal rings and both the relay and the cooking time button switch off.

Automatic use with cooking time and end time setting

Press the cooking time button and select the length of the cooking time with +or –button. The AUTO and cooking time symbols light up continuously. The relay switches on. By pressing the cooking end time button the next cooking end time appears on the display. Set the cooking end time with +button. The relay and the cooking time symbol switch off .the symbol lights up again when the time of day corresponds to the cooking start time. When the cooking time is up, the AUTO symbol flashes, the sound signal rings, the cooking time symbol and the relay switch off

Minutes counter

Press the minutes counter button and set the cooking time with +or –button.

The bell symbol lights up when the minutes counter is operating, when the set time is up, the sound rings and the bell symbol switches off.

Sound signal

The sound signal starts at the end of a programme or of the minutes counter function and it lasts for 15minutes.

To stop it, push any one of the functions buttons.

Start programme and check

The programme starts 4seconds after it has been set. The programme can be checked at any time by pressing the corresponding button.

Setting error

A setting error is made if the time of day on the clock falls within the cooking start and end times. To correct the setting error, change the cooking time or cooking end time the relays switch off when a setting error is made.

Cancelling a setting

To cancel a setting, press the cooking time button and then press the –button until 00 00 appears on the display. A set programme will automatically cancel on completion.

Operating instructions for Electronic Timer (3 keys)

1. Functional description-Overview

The operation of this timer is done 3 buttons. The functions of the buttons are:



With this arrangement it is possible to select the following four functions:

- Minute minder
- Operation period
- Operation stop
- Time-of-day

These modes can be selected by repeatedly pressing the mode button. The desired time for minute minder, operation period, operation stop or time-of-day can be set with the "+"and "–"buttons.

As an option, the duration of a pyrolysis can be controlled, if an oven features such function.

2. Programming

2.1 Draft of the display

The LED display is separated in the following way:

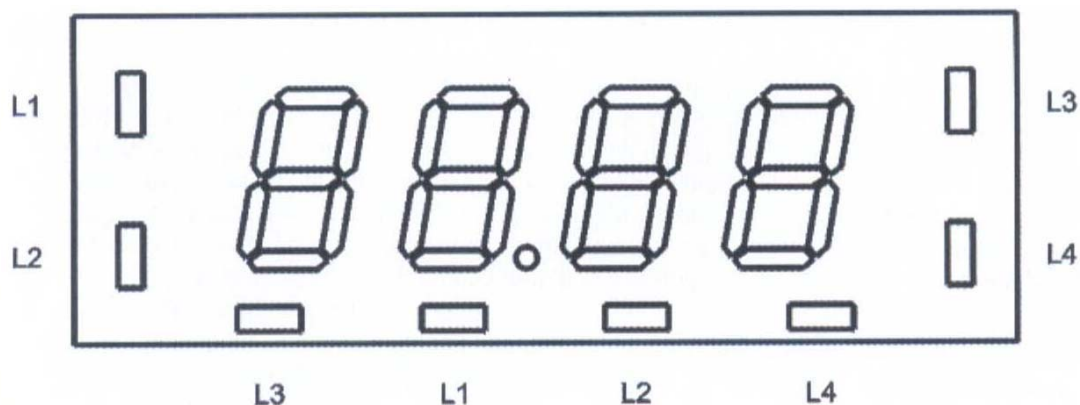

New picture with frame outside

L1: Operation period

L2: Operation end

L3: Minute minder

L4: Adjust time-of-day

Depending on the variant in hand either the 4 LEDs at the side of the display or the 4 LEDs below are active for displaying the mode.

Time of day

When connected to mains supply the display shows 12.00 o'clock and the LED L4 flashes. As long as it is flashing, it is possible to adjust the time via the plus and minus buttons.

Once the time is adjusted, it is stored approx. 5 seconds after the last operation, the LED L4 goes dark again.

It is possible to adjust the time-of-day by pressing the mode button until L4 flashes, then the time-of-day can be adjusted.

Minute minder (interval time)

In order to set the interval time, the "Mode" button has to be pressed repeatedly until LED L3 is flashing. Then the interval time can be set between 0.01 and 2.30 h by using the plus and minus buttons. After setting the interval time, it remains displayed and the LED L3 is now illuminated steadily. After the interval time has run down, the alarm signal sounds (2 beeps every 2 seconds) and the LED L3 is flashing again. Pressing any of the buttons stops the signal and the flashing, the LED goes dark and the display reverts to the time-of-day. If the alarm is not stopped manually, it terminates automatically after 2 minutes.

The minute minder can be applied at any time while other functions are operative.

Operation period

In order to set an operation period, the mode button has to be pressed repeatedly until the LED L1 is flashing. Then the desired operation period (time frame between 0.01h and 10.00h) can be set using the plus and minus buttons. Once adjusted, it will be stored after approx.. 5 seconds, the LED L1 remains illuminated steadily, and the set time starts running down. The display reverts to the time-of-day. As soon as the operation period has ended, the relay opens and the alarm signal sounds (4 beeps every 2 seconds) and the LED L1 is flashing again. Pressing any of the buttons stops the signal and the flashing, the LED goes dark and the relay closes again. If the alarm is not

stopped manually, it terminates automatically after 2 minutes.

Operation stop

In order to set an operation stop, the mode button has to be pressed repeatedly until the LED L2 is flashing. Then the desired operation stop, which is limited to a point being maximally 23.59 h in the future, can be set using the plus and minus buttons. Once adjusted it will be stored after approx. 5 seconds, and the LED L2 remains illuminated steadily. The display reverts to the time-of-day. As soon as the operation stop has been reached, the relay opens and the alarm signal sounds (4 beeps for 2 minutes) and the LED L2 is flashing. Pressing any of the buttons stops the signal and the flashing, the LED goes dark and the relay closes again.

It is possible to combine the duration and end time in order to program a delayed mode. To do this, both the operation period and operation stop time have to be set (set above). LED L1 and L2 are illuminated and the baking process will start at a point in time "operation stop minus operation period". If a baking process ought to be finished at 12.00 and shall last 1.30 h, both times have to be set in the respective modes, and the timer will switch on the oven at 10.30.

The timer is capable to avoid conflicts during the programming. (E. g. with an operation period of 60 minutes resp. 1.00 hr set, and the time-of-day being 11.34 o'clock, then the operation stop can be earliest at 12.34 o'clock.)

Please note:







A running program can be checked and corrected at any time. In order to avoid conflicts, it is not possible to set the time of day when an automatic program is active.

Operating instructions for 3 key touch digital timer (E.G.O Basic Timer)

1.0 Generally

The E.G.O Basic-Timer BT-01 is specially designed for Build in Oven and Free Standing Ranges. The BT01 is operated applying EGO Touch Control Technology.

2.0 Overview of functions and symbols:

	MINUTE MINDER
	COOKING TIME (PYROLYSIS DURATION)
	END of COOKING TIME (END of PYROLYSIS DURATION)
	TIME of DAY
	CHILD LOCK
	COOKING POT
Auto	AUTOMATIC Mode
Man	MANUAL Mode
P	PYROLYSIS Mode (Option)
L1,L2,L3	ACOUSTIC SIGNAL
23:59	7-Segment Display
99:00	Maximum adjustable MINUTE MINDER
23:59	Maximum adjustable COOKING TIME
h:min	Display hour : minutes
min:sec	Display minutes : seconds

2.1 MANUAL Mode

BT-01 remains in MANUAL Mode if no COOKING TIME or END of COOKING TIME is selected. The relay contact is closed and the symbol Man is displayed. The TIME of DAY is shown on the 7-segment display unless the MINDER is active.

2.2 AUTOMATIC Mode

If a COOKING TIME or a END of COOKING TIME is selected. BT-01 switches to AUTOMATIC Mode. The relay contact is closed during the set COOKING TIME. The symbol Auto is displayed until the COOKING TIME or the END of COOKING TIME has expired.

3.0 Touch Control

3.1 Flexible Touchpad Allocation

For individual design variants the 3 conductive keys. Can be fitted at different positions.

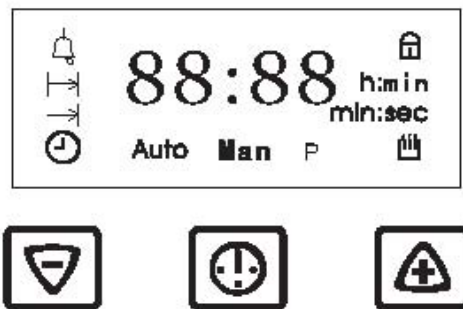

Touchpad SET(-): Conductive key fitted into Touchpad position 1 or 2

Touchpad SELECT: Conductive key fitted into Touchpad position 3

Touchpad SET(+): Conductive key fitted into Touchpad position 4 or 5

3.2 Touchpad SET(+) and SET (-)

Touching SET (+) or SET(-) pad momentarily: touching pads momentarily increases res. Decreases time by one minute (or the volume of the ACOUSTIC SIGNAL by one step).

Touching SET (+) or SET(-) pad momentarily: permanent touching increases res. Decreases the speed of time setting automatically.

Rate of change: Permanent actuation for 2...5 seconds → app.3 min/sec Permanent actuation for more than 5 seconds → app. 20 min/sec

3.3 Touchpad SELECT

Using Touchpad SELECT allows to step through the sequences of function.

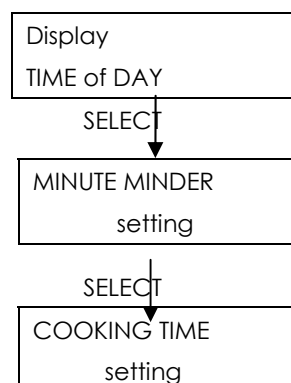

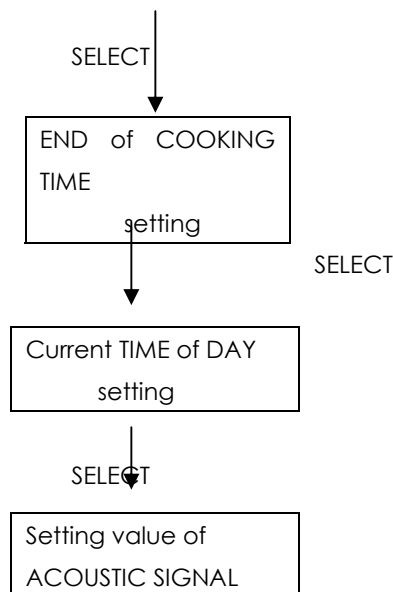

Touching Touchpad SELECT momentarily, the next following function is chosen.

Touching Touchpad SELECT permanently causes no automatic change. Touching Touchpad SELECT for more than 10 seconds an ACOUSTIC SIGNAL according chapter 5.2 occurs and the SELECT mode terminates automatically.

3.4 Touchpads SET(+) and SET(-)

Within 5 seconds after selection of a function, the time or the signal volume can be set with Touchpad SET(+) or SET (-).

4.0 Functions

4.1 Start of a function

5 seconds after setting, a set time or volume is accepted and the chosen function starts automatically. The display shows the current TIME of DAY, except the MINUTE MINDER is active. In this case the display shows the remaining time of the MINUTE MINDER.

4.2 Power ON / initial operation

Safety advice:

Line voltage 230V at the conductive keys! Do not touch without insulation.

Use correct insulation, that the user can not touch the conductive keys directly.

After connecting the unit to the mains, the display shows the default TIME of DAY 12:00 h:min flashing. In order to avoid the heaters to automatically switch on after a power failure, the relay contact opens as soon as power returns. Touching any pad the relay contact closes and the display shows the default time 12:00 h:min permanently.

The colon and the symbol ⌚ continue to flash. It is possible now to set the current TIME of DAY as described in chapter 4.3.2

4.3 TIME of DAY

4.3.1 Select TIME of DAY mode

Step through the sequences of function with Touchpad SELECT as described in chapter 3.3 until the symbol ⌚ flashes.

4.3.2 Set TIME of DAY

After 7 min. at the latest or after touching any of the Touchpads the ACOUSTIC SIGNAL stops. The symbol Man flashes further on.

Touching SELECT again, causes a change to the MANUAL mode. The symbol Man is displayed continuously, the relay contact closes and the current TIME of DAY is displayed except the MINUTE MINDER is active.

4.7 END of COOKING TIME

4.7.1 Set END of COOKING TIME

Selection as described in chapter 3.3. until the symbol END of COOKING TIME  is flashing. The END of COOKING TIME can be set with Touchpad SET (+) or SET(-) acc. Chapter 3.4. The display shows the current TIME of DAY plus the set COOKING TIME. The END of COOKING TIME can be set with Touchpad SET(+) or SET(-) acc. Chapter 3.4. The COOKING TIME can be modified according chapter 4.7.3. The latest END of COOKING TIME is limited to the current TIME of DAY plus 23:59 h:min.

4.7.2 END of COOKING TIME runs down

5 seconds after setting, the MANUAL mode changes to the AUTOMATIC mode. The display shows the symbol COOKING POT  and the current TIME of DAY, except the MINUTE MINDER is active.

4.7.3 Modifying / Deleting END of COOKING TIME

Selection as described in chapter 3.3. until the symbol END of COOKING TIME  is flashing. The END of COOKING TIME can be modified with Touchpad SET(+) or SET(-) acc. Chapter 3.4

If END of COOKING TIME is set without setting a COOKING TIME first, the END of COOKING TIME can be deleted by counting back by SET(-) until it equals current TIME of DAY.

If both, an END of COOKING TIME plus a COOKING TIME have been set, the END of COOKING TIME can be deleted acc. Chapter 4.6.3 (deleting COOKING TIME).

4.7.3 END of COOKING TIME has expired

See chapter 4.6.4

4.8 Delayed COOKING

The relay contact automatically closes upon the calculated START TIME and opens after END of COOKING TIME is reached.

Calculation of START TIME as below:

Example 1:

Current TIME of DAY		selected END of COOKING TIME
10:00 h:min	selected COOKING TIME	12:15 h:min
	1:15 h:min	

Calculation of START TIME: END of COOKING TIME minus COOKING TIME =

12:15 h:min – 1:15 h:min = 11:00 h:min

Example 2:

Current TIME of DAY		selected END of COOKING TIME
10:00 h:min	selected COOKING TIME	11:15 h:min
	1:15 h:min	

Calculation of START TIME: END of COOKING TIME minus COOKING TIME =

11:15 h:min – 1:15 h:min = 10:00 h:min

Example 2 shows that the earliest END of COOKING TIME equals to current TIME of DAY (in this case 10:00 h:min) plus COOKING TIME (in the case 1:15 h:min). Therefore in this case the earliest End of



COOKING TIME is 11:15 h:min.

COOKING TIME starts as soon as the START TIME is reached. The relay is closed and the symbol COOKING POT  is displayed.

4.8.1 Set DELAYED COOKING

1. Set desired COOKING TIME acc. Chapter 4.6.1.
2. Set desired END of COOKING TIME acc. Chapter 4.7.1

4.8.2 DELAYED COOKING runs down

The relay contact is opened and the symbol COOKING POT  is off until START TIME is reached. COOKING TIME starts as soon as the START TIME is reached. The relay is closed and the symbol COOKING POT  is displayed.

4.8.3 Modifying / Deleting DELAYED COOKING

Modifying / Deleting of COOKING TIME see chapter 4.6.3

Modifying / Deleting of END of COOKING TIME see chapter 4.7.3.

4.8.4 DELAYED COOKING has expired

See chapter 4.6.4 (COOKING TIME has expired).

4.9 CHILD LOCK

To avoid unwanted selection, setting resp. change of functions, the unit disposes a CHILD LOCK function.

4.9.1 Activation of CHILD LOCK

The CHILD LOCK function can be activated while TIME of DAY is displayed in MANUAL mode, regardless whether a COOKING TIME or an END of COOKING TIME runs down in AUTOMATIC mode. CHILD LOCK function is activated by touching SET(+) for a minimum of 5 seconds until the CHILD LOCK symbol  is displayed. From this moment on all other functions are locked.

Exception: If a function, e.g. COOKING TIME has expired, the ACOUSTIC SIGNAL can be terminated by touching any Touchpad, although the CHILD LOCK is active.

Touching any of the Touchpads while CHILD LOCK is activated causes an ACOUSTIC SIGNAL acc. Chapter 5.2 and the CHILD LOCK symbol flashes for two seconds.

4.9.2 Deactivation of CHILD

CHILD LOCK function is deactivated by touching Touchpad SET(+) again for a minimum of 5 seconds until the CHILD LOCK symbol  switches off. From this moment on all functions are selectable again.

4.9.3 CHILD LOCK in MANUAL Mode

Activating the CHILD LOCK in MANUAL mode completely locks the appliance by switching off the relay contact. The symbol Man is switched off. After deactivation according chapter 4.9.2, the symbol Man is displayed again and the relay contact closes.

4.9.3 Power failure while CHILD LOCK is activated:

The child lock remains activated after a power failure. Before renewing the settings, the CHILD LOCK has to be deactivated. See 4.9.2.

Operating instructions for full touch control PCB





Key operation:









Main on/off switch	Plus key	Minus key	Light	Timer	Info	Minus	Plus	Rapid heat-up	OK
--------------------	----------	-----------	-------	-------	------	-------	------	---------------	----

1. Time of Day / Minute Minder / Cooking time / End of time setting  :

1) Time of Day: press  to adjust the time before you switch the on/off key 



2) Minute Minder  : press  to set the cooking time, press  to start cooking. The Minute Minder count down starts to 0:00 (min:sec). The display shows the symbol  and the remaining time is displayed continuously.



3) Cooking time  : press  to set the cooking time 00:00 (hour: min), press  to start cooking.

4) End of cooking time  : after user sets the cooking time , press the key  to set the end of cooking time. The oven starts as soon as the start time reaches.

For example: The time is 12:00 now, user sets the cooking time to 0:30(hour: min), then press  to set the end of time to 12:40. The oven starts to cook at 12:10, and the display shows the remaining time of cooking.

2. Function setting



1) Press the key  to switch on the oven. User can select the different cooking modes by pressing the key .

2) Temperature can be set by the key  after the cooking mode is selected. Once the cooking mode and the temperature is fixed, press the key  to start cooking.

3. Rapid heat – up 

When the setting temperature exceeds 100 degrees and the pre-heat function hasn't been finished, user can press the key  to start the rapid heat-up mode.

4. Configuration setting:

Press the "Info" key  for 5 seconds to set the mode. Then press the "Info" again to select Mode 1, Mode 2, Mode 3, Mode 4, Mode 5, Mode 6. Once selecting the mode, user can press  to select option 1, 2 or 3.

Mode	Description	Option 1	Option 2	Option 3
------	-------------	----------	----------	----------

Mode 1	Time display	Display always	Display when oven is working	
Mode 2	"Beep" sound after the time count down	Short	Medium	Long
Mode 3	Duration of time setting	Short	Medium	Long
Mode 4	Cooling fan working time after oven finishes cooking	Short	Medium	Long
Mode 5	Display brightness	Dark	Medium	Bright
Mode 6	"Beep" sound when selecting the function mode	No	Yes	

After user finish the selection of "Info" mode, press the key  to confirm.

5. Cooking mode symbol:

The sequence of cooking modes displayed in the screen as below:

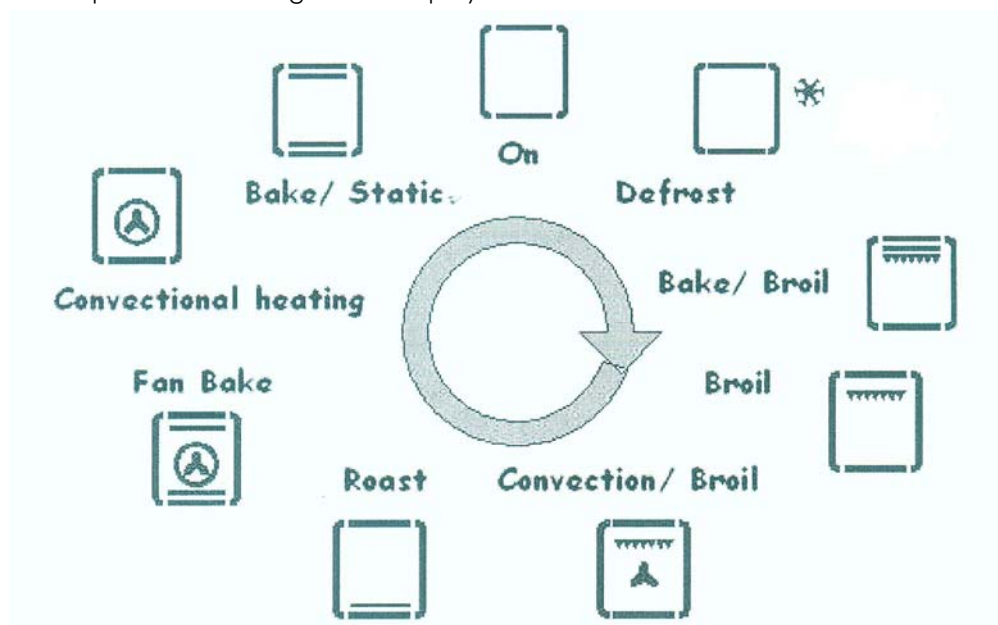

6. Child-safety lock: Press the  button for 5 sec after you switch off the oven.

How to keep Your Oven in Shape

This appliance is for household use only, don't use it outdoors!

Important: Unplug your oven before cleaning, or performing maintenance!

To extend the life of your oven, it must be cleaned frequently, keeping in mind that:

- ⦿ **Do not uses steam equipment to clean the appliance.**
- ⦿ To protect against the risk of electrical shock, do not immerse the unit, cord or plug in water or other liquid or sprinkle water to clean the appliance!
- ⦿ Don't clean the appliance when it still hot! The inside and external surface of the oven should preferably be cleaned by damp cloth when it is cooled down.

- ⦿ Wash all accessories in hot sudsy water or in a dishwasher, wipe dry with a paper or cloth towel.
- ⦿ If you use your oven for an extended period of time, condensation may form. Dry it using a soft cloth.
- ⦿ There is a rubber seal surrounding the oven opening which guarantees its perfect functioning. Check the condition of this seal on a regular basis. If necessary, clean it and avoid using abrasive products or objects to do so. Should it become damaged, please contact your nearest After-sales Service Centre. We recommend you avoid using the oven until it has been repaired.
- ⦿ Never line the oven bottom with aluminium foil, as the consequent accumulation of heat could compromise the cooking and even damage the enamel.
- ⦿ Clear the glass door using damp cloth and dry it with a soft cloth.

Do not use harsh abrasive cleaners or sharp metal scrapers to clean the oven door glass since they can scratch the surface, which may result in shattering of the glass.

Replacing the Lamp in the Oven

- ⦿ Unplug your oven!
- ⦿ Unscrew the glass cover attached to the lamp holder;
- ⦿ Unscrew the lamp and replace it with another high-temperature lamp (300°C) with the following characteristics:

- Voltage: AC220V-240V
- Wattage: 15W
- Socket: E 14

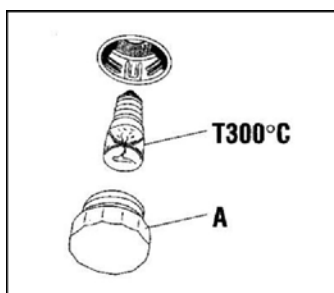

- ⦿ Remount the glass cover and reconnect the appliance to the power supply.

WARNING: Ensure that the appliance is unplugged before replacing the lamp to avoid the possibility of electric shock.

Warning: Do not operate appliance with damaged cord or plug or after the appliance malfunctions, or has been damaged in any manner, return appliance to the nearest Authorized Service Center for examination. Repair, or adjustment!

USEFUL NOTES FOR COOKING

In the following table, some indicative hints for cooking:

FAULTS	CAUSES	REMEDIES
The upper crust is dark and the lower part too pale	Not enough heat from the bottom	<ul style="list-style-type: none"> - Use the natural convection position - Use deeper cake tins - Lower the temperature - Put the cake on a lower shelf
The lower part is dark and the upper crust too pale	Excessive heat from the bottom	<ul style="list-style-type: none"> - Use the natural convection position - Use lower side tins - Lower the temperature

		- Put the cake on a higher shelf
The outside is too cooked and the inside not cooked enough	Too high temperature	- Lower the temperature and increase the cooking time
The outside is too dry even though of the right color	Too low temperature	- Increase the temperature and reduce the cooking time.

Protective kit

During operation, the oven glass door and adjacent parts of the appliance become hot. Make sure, therefore, that children do not touch the appliance.

This appliance is not intended for use by persons (including children) with reduced physical, sensory or mental capabilities or lack of experience and knowledge, unless they have been given supervision or instruction concerning use of the appliance by a person responsible for their safety.

Children should be supervised to ensure that they do not play with the appliance.

For greater safety, an additional child-safety device is available from our Head Office and our Authorised Service Centres (see enclosed list). When ordering this, please give the code: BAB-followed by the appliance model. The model is stamped on the plate which is visible on the front part of the oven upon opening the door.

Disassembling/assembling the oven door

To make it easier to clean the inside of your oven, the oven door can be removed, by proceeding as follows (fig. 11):

- Open the door completely and lift the 2 levers "B" (fig.11-1);
- Now, shutting the door slightly, you can lift it out by pulling out the hooks "A" as shown in figure 2.

To reassemble the door:

- With the door in a vertical position, insert the two hooks "A" into the slots;
- Ensure that seat "D" is hooked perfectly onto the edge of the slot (move the oven door backwards and forward slightly);
- Keep the oven door open fully, unhook the 2 levers "B" downwards and then shut the door again.

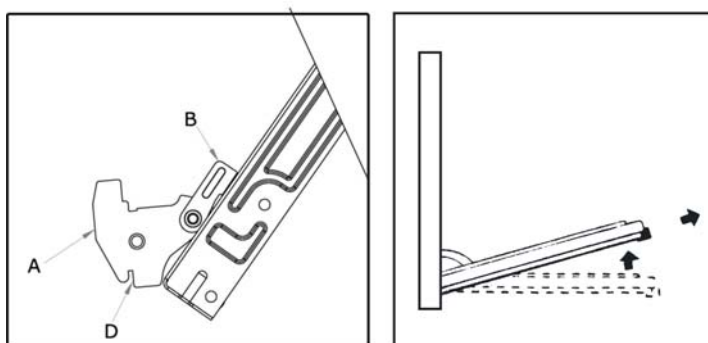

Fig.11-1

Fig.11-2

the side door can be removed , by proceeding as follows (fig.12):

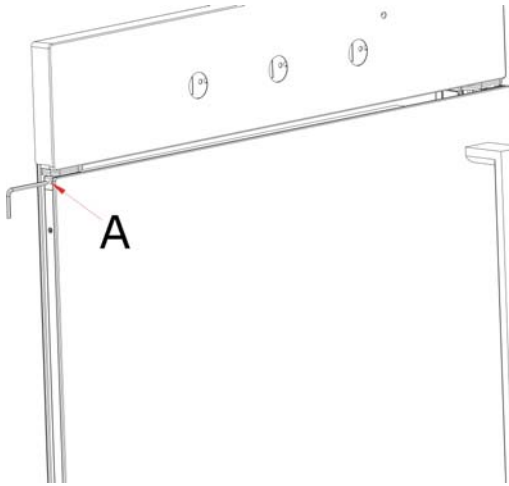

Fig.12-1

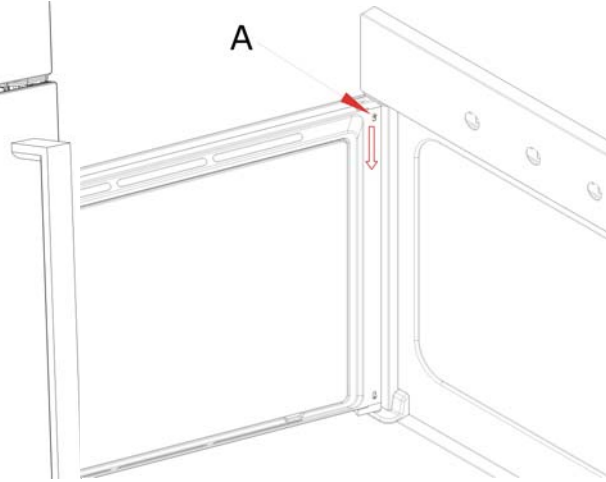

Fig.12-2

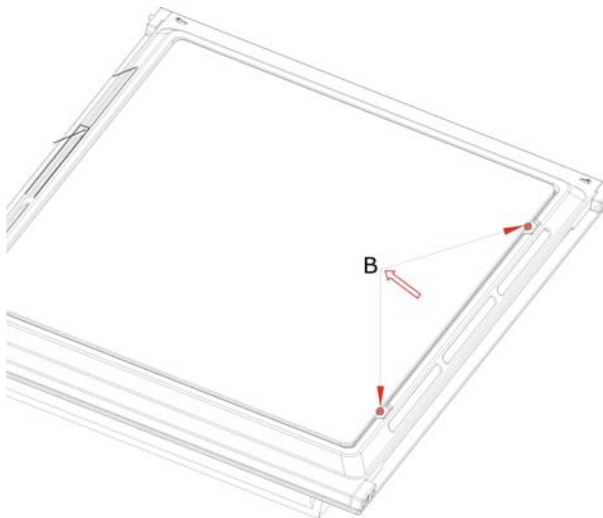

Fig.12-3

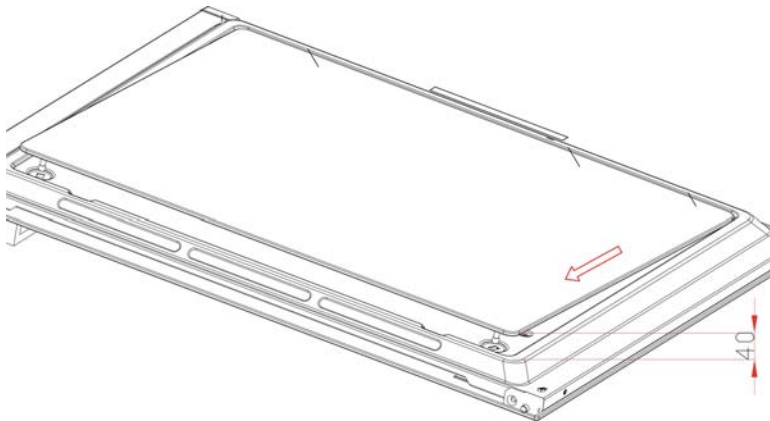

Fig.12-4

Removal of Side-door oven

- a) by opening the door, take out the screw at position A by a screwdriver, then you can take the whole oven door separately.(fig.12-1, fig.12-2)
- b) put the oven door on a flat surface, use a flatten objects, such as coins, to levering the glass at the position B.(fig.12-3)
- c) make the glass on the postion of with about 40mm height, DO NOT take it too high as it will broken the frame. Then pull it glass out with the direction as fig.12-4. In this way, it is easy to clear the glass of oven door.

Remark:

If only want to clear the internal glass, not the whol oven door, just opperate with instruction b) and c).



This product must not be disposed together with the domestic waste. This product has to be disposed at an authorized place for recycling of electrical and electronic appliances.

By collecting and recycling waste, you help save natural resources, and make sure the product is disposed in an environmental friendly and healthy way.

Important: if you decide not to use the oven any more, it should be made inoperable by cutting the power supply cable, after unplugging it from the power supply. Disused appliances can be a safety risk as children often play with them. For this reason it is advisable to make the oven safe.