

EUROMAID

**installation & operating
instructions and cooking
guidance**

Double Oven with grill

Model CD 60

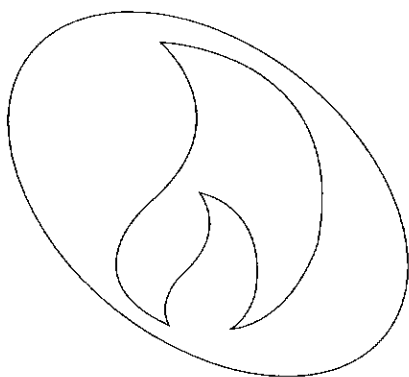

get the **best** from your new cooker

Please read these instructions before installation or using your appliance!

Dear Customer,

By purchasing this product you have chosen an appliance of advanced technology and high quality.

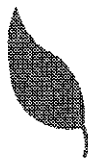

The appliance was produced in modern facilities which meet all environmental standards.

The instructions will help you to operate the appliance quickly and safely.

- Upon delivery, please check that the appliance is not damaged. If you note any transport damage, please contact your point of sale immediately and do not connect and operate the appliance!
- Before you connect and start using the appliance, please read this manual and all enclosed documents. Please note in particular the safety instructions.
- Keep all documents so that you can refer to the information again later on. Please keep your receipt for any repairs which may be required under warranty.
- When you pass on the appliance to another person, please provide all documents with it.

Table of Contents

1	General information	4
	Overview	4
	Technical Data	5
	Accessories supplied with the unit.....	6
2	Safety instructions	7
	Explanation of safety instructions	7
	Basic safety instructions.....	7
	Safety for children.....	8
	Safety when working with electricity	8
	Intended use.....	9
	Disposal	9
	Packaging material	9
	Old equipment	9
	Future transportation	9
3	Installation	10
	Before installation	10
	Installation and connection.....	11
	Splashback assembling.....	11
4	Preparation	14
	Tips for saving energy	14
	Initial operation	14
	Setting the time.....	14
	First cleaning of the appliance.....	15
	Initial heating.....	15
5	How to use the hob	16
	General information on cooking.....	16
	How to use hobs.....	16
6	How to operate the oven	18
	General information on baking, roasting and grilling	18
	How to use the electric oven	18
	How to operate the oven timer	19
	Cooking times table	20
	How to operate the top oven part.....	21
	Cooking times table	21
	How to operate the grill -Top oven.....	22
	Top oven cooking times table for grilling	22
	How to use the alarm clock	23
7	Maintenance and care	24
	General information	24
	How to clean the hob.....	24
	Cleaning the control panel.....	24
	Cleaning the oven	24
	Removal of oven door.....	25
	Replacing the oven lamp	26
8	Troubleshooting	27

1 General information

Overview

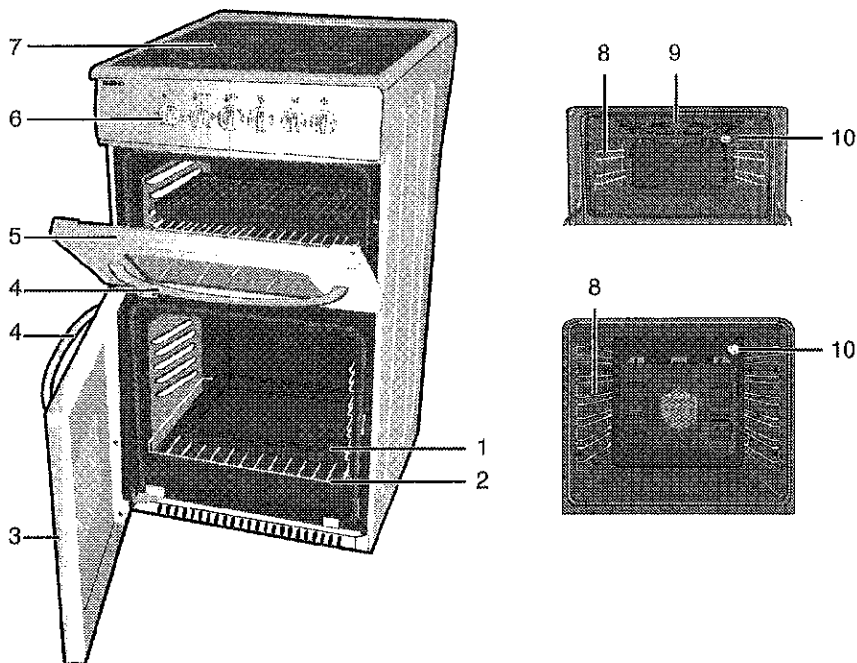

- | | | | |
|---|----------------|----|-----------------------|
| 1 | Tray | 6 | Control panel |
| 2 | Wire shelf | 7 | Burners' plate |
| 3 | Main oven door | 8 | Shelf positions |
| 4 | Handle | 9 | Grill heating element |
| 5 | Top oven door | 10 | Lamp |

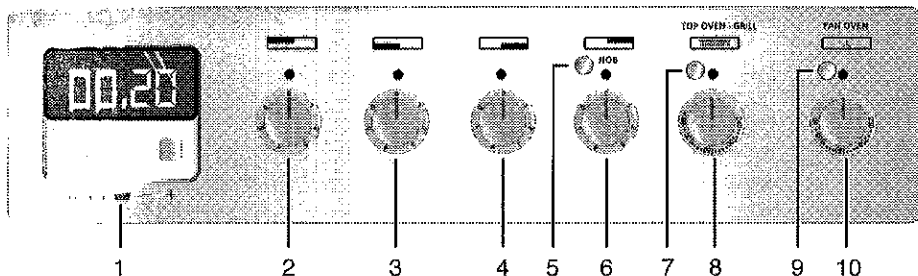

- | | | | |
|---|--|----|---|
| 1 | Digital timer | 6 | Single-circuit cooking plate Rear right |
| 2 | Single-circuit cooking plate Rear left | 7 | Thermostat lamp for top oven |
| 3 | Single-circuit cooking plate Front left | 8 | Top oven function knob |
| 4 | Single-circuit cooking plate Front right | 9 | Thermostat lamp for main oven |
| 5 | Warning lamp | 10 | Main oven function knob |

Technical Data

GENERAL	
Outer dimensions (height/width/depth)	900 mm/600 mm/600 mm
Voltage/frequency	230-240 V ~ / 400-415 V 50 Hz
Total electric consumption	10.2 kW
Fuse protection	min. 16 A x 3 / 32 A
Cable type / cross section	H05VV-FG 5 x 1,5 mm ² / 3 x 2,5 mm ²
Cable length	max. 2 m
HOB	
Burners	
Rear left	Single-circuit cooking plate
Size	140 mm
Power	1200 W
Front left	Single-circuit cooking plate
Size	180 mm
Power	1700 W
Front right	Single-circuit cooking plate
Size	140 mm
Power	1200 W
Rear right	Single-circuit cooking plate
Size	180 mm
Power	1700 W
OVEN/GRILL	
Top oven	Conventional oven/Grill oven
Energy efficiency class [#]	A
Inside illumination	15-25 W
Grill power consumption	2.2kW
Main oven	Fan oven
Energy efficiency class [#]	A
Inside illumination	15-25 W

[#] Basis: In electrical ovens, the data on energy labels are in conformity with EN 50304. Values were determined under standard load and convection/hot air (if available). Heating mode with an energy efficiency rating specified by EN 50304 is determined in accordance with below priority order depending on functions (modes) availability on the product. 1- Eco fan heating, 2-Slow cooking, 3-Fan heating (hot air), 4-Top and bottom heat with convection air, 5-Top and bottom heating.

Accessories supplied with the unit

i Accessories supplied can vary depending on the product model. All the accessories described in the user manual may not exist on your product.

Small baking tray

Can be used for small portions. This baking tray is placed onto the wire shelf.

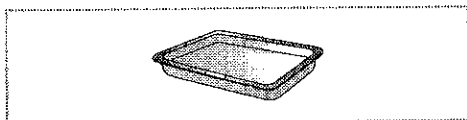

Wire shelf

Can be used for roasting and as deposit for baking, roasting and casserole dishes.

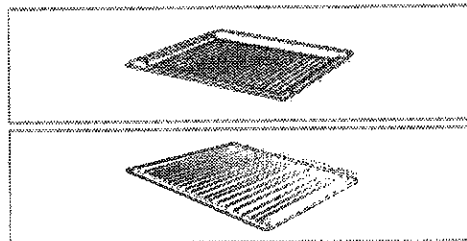

Small wire shelf and fat pan with handle

Can be used for both grilling and fat collection. The fat pan is placed onto the large wire shelf.

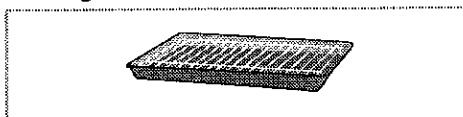



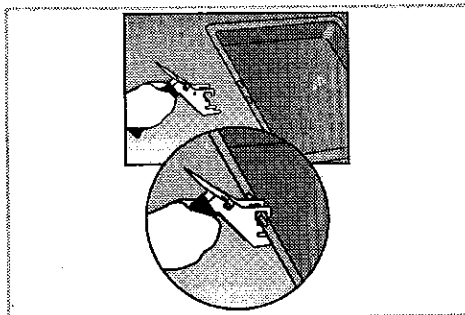

- Apply handle only at the holes in the middle of the fat pan.
- Remove handle for grilling.



2 Safety instructions

Explanation of safety instructions

The following types of safety instructions and information are used in this manual. They can be distinguished by the symbol and the initial signal word.

-  **High risk of personal injury.**
Non-observance may or will cause serious injuries or death.
-  **Risk of personal injury.**
Non-observance may or will cause minor or medium injuries.
-  **Risk of material damage.**
Non-observance may or will cause damage on the appliance or other objects.
-  **Tip for the user.**
Useful information on how to use the appliance. No injury risk information.

Basic safety instructions

- The manufacturer reserves its right to make changes in the technical specifications in order to improve the appliance quality without any prior notice. Figures included in this manual are for schematic purpose only and may not match exactly with your appliance. Values stated on the markings of the appliance or in other printed documents supplied with the appliance are obtained under laboratory conditions as per relevant standards. These values may vary according to the usage of the appliance and ambient conditions.
- This appliance is not intended for use by persons (including children) with reduced physical, sensory or mental capabilities, or lack of experience and knowledge, unless they have been given supervision or instruction concerning use of appliance by a person responsible for their safety. Children should be supervised to ensure that they do not play with the appliance.
- "An additional protective means to avoid contact with the oven door is available. This part should be fitted when young children are likely to be present."
- Never use when judgement or coordination is impaired by the use of alcohol and/or drugs.
- Do not operate the appliance if it is defective or shows any visible damage.
- Do not carry out any repairs or modifications on the appliance. However, you may remedy some malfunctions; see *Troubleshooting*, page 27.
- Be careful when using alcoholic drinks in your dishes. Alcohol evaporates in high temperatures and may catch fire when it comes in contact with hot surfaces.
- Do not heat closed food containers and glass jars. Pressure that may build-up in the jar can cause it to burst.

- Ensure that no flammable materials are adjacent to the appliance as the sides become hot during use.
- Do not leave empty pots or pans on plates that are switched on. They may get damaged.
- Since it may be hot, do not leave plastic or aluminum dishes on the surface of appliance. These kind of dishes should not be used to keep food either.
- Do not place baking trays, dishes or aluminium foil directly onto the bottom of the oven. The heat accumulation might damage the bottom of the oven. Keep all ventilation slots clear of obstructions.
- Appliance may be hot when it is in use. Never touch the hot burners, inner sections of the oven, heating elements etc. Keep children away!
- Always use heat-resistant gloves when putting or removing the dishes into/from your oven.
- Don't use the cooker with front door glass removed.
- Rear surface of the oven gets hot when it is in use. Gas / Electric connection should not touch the rear surface, otherwise the mains cable may get damaged. Do not trap the mains cable between the hot oven door and frame. Do not route the mains cable over the hot cooking section. Otherwise, cable insulation may melt and cause fire as a result of short circuit.
- Check all controls on the appliance are switched off after use.

- ⓘ For the warranty to be valid, the appliance must be installed by a qualified person in accordance with current regulations.

Safety for children

- Accessible parts of the appliance will become hot whilst the appliance is in use and until the appliance has cooled, children should be kept away.
- Accessible parts may be hot when the grill is in use. Young children should be kept away.
- Do not store any items above the appliance that children may reach.
- The packaging materials will be dangerous for children. Keep the packaging materials away from children. Please dispose of all parts of the packaging according to environmental standards.
- When the door is open, do **not** load any heavy object on it and do **not** allow children to sit on it. It may overturn or door hinges may get damaged.

Safety when working with electricity

- Any work on electric equipment and systems may only be carried out by authorized qualified persons.
- In case of any damage, switch off the appliance and disconnect it from the mains supply by removing the fuse or switching off the circuit breaker.
- Ensure that the fuse rating is correct.

Intended use

The appliance is designed for domestic use only. Commercial use is not admissible.

This appliance should not be used for warming the plates under the grill, hanging towels and dish cloths etc. on the handles, drying and for heating purposes.

This product should not be used for heating purposes.

The manufacturer shall not be liable for any damage caused by improper use or handling errors.

The appliance can be used for defrosting, baking, roasting and grilling food.

Disposal

Packaging material

 Risk of suffocation by the packaging materials!
Keep children away from the packaging materials.

The packaging material and transport locks are made from materials that are not harmful to the environment. Please dispose of all parts of the packaging according to environmental standards. This is beneficial to the environment.

Old equipment



This appliance bears the selective sorting symbol for waste electrical and electronic equipment (WEEE). This means that this appliance must be

handled pursuant to European Directive 2002/96/EC in order to be recycled or dismantled to minimize its impact on the environment. For further information, please contact your local or regional authorities.

Electronic appliances not included in the selective sorting process are potentially dangerous for the environment and human health due to the presence of hazardous substances.

Future transportation

 Do not place other items on the top of the appliance. The appliance must be transported upright.

Store the appliance's original box and transport the appliance in its original carton. Follow the guidance marks that are printed on the carton.

 Verify the general appearance of your equipment by identifying possible damage during the transportation.

To prevent the wire shelf and tray inside the oven from damaging the oven door, place a strip of cardboard onto the inside of the oven door that lines up with the position of the trays. Tape the oven door to the side walls.

If you do not have the original carton

Pack the appliance in bubble wrap or thick cardboard and tape it securely in order to prevent damage during transportation.

3 Installation

Before installation

To ensure that critical air gaps are maintained under the appliance, we recommend that this appliance is mounted on a solid base and that the feet do not sink into any carpet or soft flooring.

The kitchen floor must be able to carry the weight of the appliance plus the additional weight of cookware and bakeware and food.

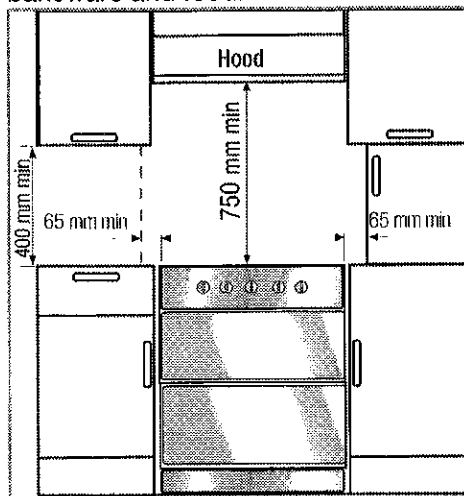

A safety distance must be left between the appliance and the kitchen walls and furniture. See figure (values in mm).

- It can be used with cabinets on either side but in order to have a minimum distance of 400mm above hotplate level allow a side clearance of 65mm between the appliance and any wall, partition or tall cupboard.
- It can also be used in a free standing position. Allow a minimum distance of 750mm from the hob surface to adjacent

surfaces above the hob surface and 600mm to a cabinet above.

- If a appliance hood is to be fitted, refer to the manufacturer's instructions regarding fixing height.
 - Movement of your appliance is most easily achieved by lifting the front as follows and pulling towards. Open the top oven door and the bottom oven door sufficiently to allow a comfortable grip on the underside front edge of the oven roofs. While gripping, it should be avoided to damage any grill elements or oven interior furniture.
 - The appliance corresponds to device class 1, i.e. it may be placed with the rear and **one** side to kitchen walls, kitchen furniture or equipment of any size. The kitchen furniture or equipment on the **other** side may only be of the same size or smaller.
 - Any kitchen furniture next to the appliance must be heat-resistant (100 °C min.).
- i** The appliance must be secured against overbalancing by using the supplied chain on your oven. Fasten hook (1) to the kitchen wall (5) and connect safety chain (2) to the hook.

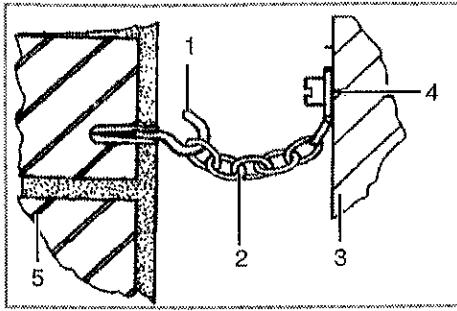

- 1 Hook (is not supplied)
- 2 Safety chain (supplied and mounted to oven)
- 3 Rear of cooker
- 4 Firmly fix chain to cooker rear
- 5 Kitchen wall

Installation and connection

- i** Do not install the appliance next to refrigerators or freezers. The heat emitted by the appliance will lead to an increased energy consumption of cooling appliances.
- For installation the appliance must be connected in accordance with all local gas and/or electrical regulations.
- Carry the appliance with at least two persons.
- i** **Material damage!**
The door and/or handle must not be used for lifting or moving the appliance.
- The appliance must be placed directly on the floor. It must not be placed onto a base or a pedestal.
- ⚠** **Risk of explosion by damage of the safety tube!**
The safety tube must not be clamped, bent or trapped or come into contact with hot parts of the appliance.

Splashback assembling

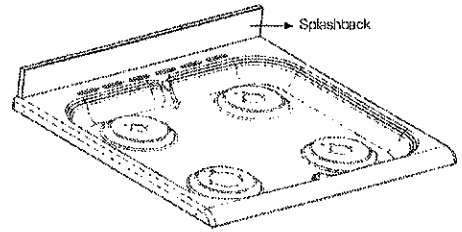

1. Please take splashback and package of screws, nuts, fillers from warmer drawer.
2. Place splashback according to the drawing, place nut inside splashback on to the hole, screw the splashback to the burner plate's with screw from under burner plate.
3. If you don't want to install splashback on to your cooker, you can place fillers to the holes.

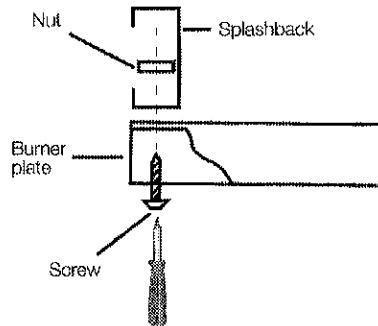

Connection to the mains supply

This appliance must be earthed!

Our company shall not held responsible for any damage caused by using the appliance without earthed socket.

 Risk of electric shock, short circuit or fire by unprofessional installation!
The appliance may be connected to the mains supply only by an authorized qualified person and the appliance is only guaranteed after correct installation.

 Risk of electric shock, short circuit or fire by damage of the mains lead!
The mains lead must not be clamped, bent or trapped or come into contact with hot parts of the appliance.
If the mains lead is damaged, it must be replaced by a qualified electrician.

The mains supply data must correspond to the data specified on the rating plate of the appliance. The rating plate is either seen when the door or the lower cover is opened or it is located at the rear wall of the appliance depending on the appliance type.

The supply cable of the appliance must correspond to the specifications; see technical data table *Technical Data*, page 5.

 Risk of electric shock!
Before starting any work on the electrical installation, please disconnect the appliance from the mains supply.

1. A mains lead is not supplied with the appliance, It must connect a mains lead to your appliance that you would select from the table on basis of the installation at your home, following the instructions in the wiring diagram.

If no all-pole separation from the mains supply is possible, a separation appliance must be connected with a contact distance of 3 mm min. (fuses, line safety switches, contactors) all poles which should be adjacent to (but not above) the appliance in accordance with IEE regulation. Failure to observe this instruction may result in operational problems and invalidation of the appliance warranty. Additional protection by a residual current circuit breaker is recommended.

2. Open the terminal block cover with screwdriver.
3. Pass the mains lead through the cable clamp under the terminal and fix the mains lead to main body with supplied screw via cable tightener.
4. Connect the cables according to the supplied diagram.
5. Close the cover of the terminal block once the wiring is complete.

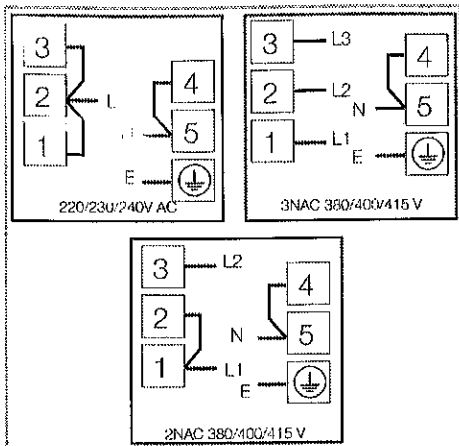

i Mains lead must not be longer than 2 metres for safety reasons.

6. The mains lead should be routed away from the appliance and not be trapped between the appliance and the wall.

- Position appliance up to the kitchen wall.
- Securely attach safety chain to the wall behind the cooker.
- To align the appliance with the worktop, adjust the feet turning right or left hand as required.

Final check

1. Switch electricity supply on.
2. Check electrical functions.

4 Preparation

Tips for saving energy

The following tips will help you to use your appliance in an ecological way and to save energy:

- Use dark coloured and enamel coated trays, since the heat transmission will be better.
- While cooking your meals, perform a preheating operation if it is advised in the user manual or cooking instructions.
- During cooking, do not open the oven door frequently.
- Try to cook more than one type of meal within the oven at the same time (You can cook two different meals at the same time by locating cooking bowls on the same shelf). It will be suitable to cook more than one meal after each other. The oven will already be hot.
- Defrost frozen meals before cooking them.
- You can save energy by switching off your oven a few minutes before the end of the cooking time (The oven door should not be opened).
- Use pots/pans with lids for cooking. Without a lid, the energy consumption may be up to four times higher.
- Choose the burner/plate which is suitable to the saucepan base. Always choose the correct size of saucepans for your meals. For larger burners/plates more energy is needed.

- Take care to use flat base saucepans while cooking on electrical cookers. Pots with an even and thick bottom provide better thermal conduction. You can save up to 1/3 of electricity.
- Pots and pans should match the size of plates. The bottom of the pot or pan should not be smaller than the plate.
- Keep plates and pan bottoms clean. Dirt will reduce the heat transmission between plate and pan bottoms.
- In case of longer cooking times, switch off the plate 5 to 10 minutes before the end of the cooking time. When you use the residual heat, you can save up to 20 % of electricity.

Initial operation

Setting the time

- ❗ Before using the oven the clock time must be set. If the clock time is not set, the main oven will not work.

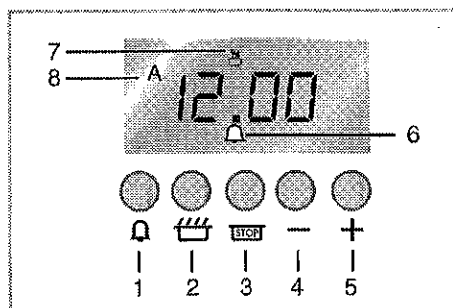

Keys for:

- 1 Alarm clock
- 2 Cooking time
- 3 End of cooking time
Keys for time adjustment:
- 4 Minus key
- 5 Plus key
Display symbols for:
- 6 Alarm clock
- 7 Cooking
- 8 Automatic

1. Keep key 2 and key 3 pressed.
2. Set clock with key 4 or key 5. By pressing the key shortly, you advance or reset the clock by one minute. When you keep the individual key pressed, the minutes are advanced or reset quickly.
3. Release key 2 and key 3.

First cleaning of the appliance

 The surface may get damaged by some detergents or cleaning materials.

Do not use aggressive detergents, cleaning powder/cream or any sharp objects.

1. Remove all packaging materials.
2. Wipe the surfaces of the appliance with a damp cloth or sponge and dry with a cloth.

Initial heating

 Hot surfaces may cause burns! Do not touch the hot surfaces of the appliance. Use oven gloves. Keep children away from the appliance.

 Smell and smoke may emit during first heating. Ensure that the room is well ventilated.

Any production residues or conservation layers must be burnt off before the first use. Heat up the appliance for about 30 minutes and then switch it off.

Electric oven

1. Take all baking trays and racks from the oven.
2. Close oven door.
3. Select the highest temperature with the thermostat knob; see *How to use the electric oven, page 18*.
4. Heat approximately 30 minutes.
5. Switch off oven; see *How to use the electric oven, page 18*

Grill oven

1. Take all baking trays and wire shelf from the oven.
2. Close oven door.
3. Select highest oven power of the grill oven; see *How to operate the top oven part, page 21*.
4. Heat approximately 30 minutes.
5. Switch off grill; see *How to operate the top oven part, page 21*

5 How to use the hob

General information on cooking

- ⚠ Risk of fire by overheated oil!
When you heat oil, do not leave it unattended.

Never try to extinguish the fire with water! When oil has caught fire, immediately cover the pot or pan with a lid. Switch off the hob if safe to do so and phone the fire service.

- Ensure handles of pans cannot accidentally be caught or knocked and do not get hot by adjacent heating zones. Avoid pans that are unstable and easily tipped. Pans that are too heavy to move easily when filled can also be a hazard. Only use flat bottomed pots or pans.
- Use pans which have sufficient capacity for the amount of food being cooked so they don't boil over and cause unnecessary cleaning.
Do not place lids on the burners. Always position pans centrally over the burners. When transferring pans from one burner to another always lift the pans do not slide them.

Tips for glass ceramic hobs

- The glass ceramic surface is heat-resistant and insensitive to large temperature deviations.
- Do not use the glass ceramic hob for keeping objects or as cutting surface.

- Use pot and pans with ground bottoms. Sharp edges cause scratches on the surface.
- Do not use aluminium pots and pans. Aluminium damages the glass ceramic surface.

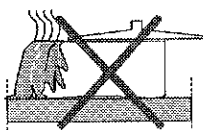

Splashes may damage the ceramic surface and can cause fire.

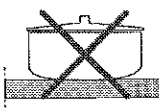

Do not use pots that have concave or convex bottoms.

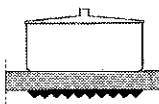

Use pot and pans with smooth bottoms. They ensure a good heat transfer.

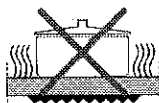

If the pan is too small energy is wasted

How to use hobs

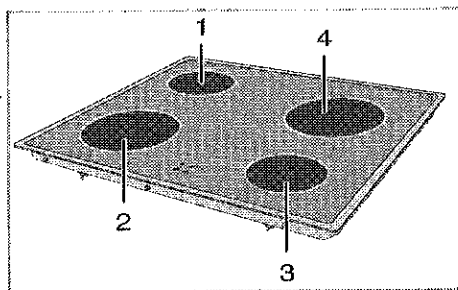

- 1 Single-circuit cooking plate 14-16 cm
- 2 Single-circuit cooking plate 18-20 cm
- 3 Single-circuit cooking plate 14-16 cm
- 4 Single-circuit cooking plate 18-20 cm is list of advised diameter of pots to be used on related burners.

▲ Broken glass!

Do not let any objects fall onto the hob. Even small objects (e.g. salt shaker) may damage the hob.

Do not use glass ceramic hobs with cracks. Water may enter into the cracks and cause a short circuit.

If the surface is damaged in any way (e. g. visible cracks), switch off the device immediately to reduce the risk of an electric shock.

The glass ceramic hob is equipped with an operating lamp and a residual heat indicator.

The residual heat indicator indicates the position of the switched on plate and remains illuminated after switching off. (When the temperature of the plate falls below touchable temperature the indicator light will go off). Weak flicker

illumination is not a problem at residual heat indicator light.

i Quick heating glass-ceramic hobs emit a bright light when they are switched on. Do not stare to bright light.

Switching the plate on

The hob control knobs are used for operating the plates. To obtain the desired cooking power, turn the hob control knobs to the corresponding level.

Cooking level	1	2 – 3	4 – 6
	warming	stewing, simmering	cooking, roasting

Switching the plate off

Turn hob control knob to off position (top).

6 How to operate the oven

General information on baking, roasting and grilling

-  Risk of scalding by hot steam!
Take care when opening the oven door as steam may escape.

Tips for baking

- Use non-stick coated appropriate metal plates or aluminum containers or heat-resistant silicone moulds.
- Make best use of the space on the rack.
- It is recommended to place the baking mould in the middle of the rack.
- Select the correct shelf position before turning the oven or grill on - don't move oven shelves when hot.
- Keep the oven door closed.

Tips for roasting

- Seasoning with lemon juice and black pepper will improve the cooking performance when cooking a whole chicken, turkey or a large piece of meat.
- Meat with bones takes about 15 to 30 minutes longer before it is cooked than a roast of the same size without bones.
- You should calculate about 4 to 5 minutes cooking time per centimeter height of the meat.
- Let meat rest in the oven for about 10 minutes after the cooking time. The juice is better distributed all over the roast and does not run out when the meat is cut.

- Fish in a fire-resistant dish should be placed on the rack at the medium or lower level.

Tips for grilling

Grilling is ideal for cooking meat, fish and poultry and will achieve a nice outer surface without it drying out too much. Flat pieces, meat skewers and sausages are particularly suited for grilling as are vegetables with a high water content such as tomatoes and onions.

- Distribute the pieces to be grilled on the wire shelf.
- If the grilling is on the wire shelf, locate a dripping pan under it in order to collect the fat.
- Add some water in the dripping pan for easy cleaning.

How to use the electric oven

-  Before using the oven the clock time must be set. If the clock time is not set, the main oven will not work.

Select temperature and operating mode

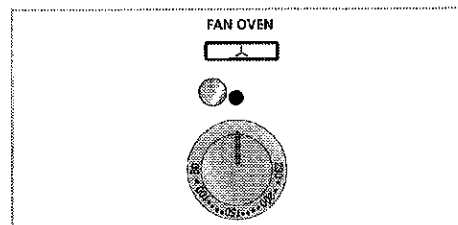

1. Set the function knob to the desired temperature.
 - » The oven heats up to the adjusted temperature and maintains it. During heating, temperature lamp stays on.

Switch off electric oven

Turn function knob to off position (top).

How to operate the oven timer

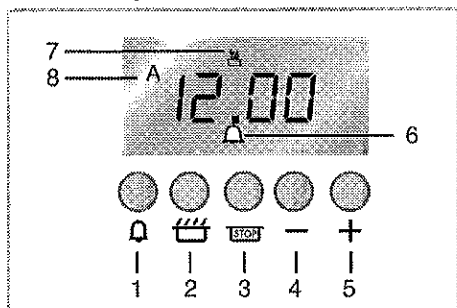

Keys for:

- 1 Alarm clock
- 2 Coking time
- 3 End of cooking time

Keys for time adjustment:

- 4 Minus key
- 5 Plus key

Display symbols for:

- 6 Alarm clock
- 7 Cooking
- 8 Automatic

i The maximum time to be set for the end of the cooking process is 23 hours and 59 minutes. In case of power cut, program will be canceled. Reprogram is needed.

i When you press key **2** during the cooking process, the display will show the remaining cooking time for a short moment.

Switch on fully automatic operation

In this mode of operation, you can define when the oven is to 'go on/off' automatically.

1. Keep key **2** pressed.
2. Use key **4** or key **5** to set the time at which the dish in the oven shall be cooked. By pressing the key shortly, you advance or reset the clock by one minute. When you keep the key pressed, the minutes are advanced or reset quickly.
3. Release key **2**.
 - » The automatic symbol is illuminated on the display.
4. Keep key **3** pressed.
5. Set end of the cooking time with key **4** or key **5**. By pressing the key shortly, you advance or reset the clock by one minute. When you keep the key pressed, the minutes are advanced or reset quickly.
6. Release key **3**.
7. Put your dish into the oven.
8. Select operating mode and temperature.
 - » The oven is heated up to the set temperature and keeps this temperature until the end of the cooking time that has been selected. During the cooking process, the cooking symbol on the display is lit.
9. Press key **2** as soon as the cooking process has been completed and an alarm sounds.
10. Switch the oven off with the thermostat knob and/or the function knob.
11. Press key **2** and key **3** simultaneously.
 - » The automatic symbol is illuminated on the display. The cooking symbol is on, indicating the oven is ready again for direct operation without time.

Switch on semi-automatic operation

In semi-automatic mode you can define when the oven is to 'turn off' automatically.

1. Keep key **2** pressed.

 The maximum cooking time can be 10 hours.

2. Use key **4** or key **5** to set the time at which the dish in the oven shall be cooked. By pressing the key shortly, you advance or reset the clock by one minute. When you keep the key pressed, the minutes are advanced or reset quickly.

3. Release key **2**.

» The number **8** is shown in the display.

4. Put your dish into the oven.

5. Select operating mode and temperature.

» The oven is heated up to the set temperature and keeps this temperature until the end of the cooking time that has been selected. During the cooking process, the cooking symbol on the display is lit.

6. Press key **2** as soon as the cooking process has been completed and an alarm sounds.

7. Switch the oven off with the thermostat knob and/or the function knob.

8. Press key **2** and key **3** simultaneously.

» The automatic symbol disappears from the display. The cooking symbol is on, indicating the oven is ready again for direct operation without time.

Interrupting the cooking process

1. Press key **2** and key **3** simultaneously.

» The automatic symbol is illuminated on the display. The cooking symbol is on, indicating the oven is ready again for direct operation without time.

2. Switch the oven off with the thermostat knob and/or the function knob.

Cooking times table

 The values indicated in the table below are data indicative. They may vary according to the type of food as well as your preferences of cooking.

Baking and roasting

 Level 1 is the **bottom** level in the oven.

Food	Rack position	Temperature	Cooking time (approx.)
Roast beef	2	160...180 °C	20...25 min. per 450 g
Roast lamb	2	160...180 °C	25 min. per 450 g
Roast pork	1...2	160...180 °C	25 min. per 450 g
Poultry - up to 4.0 kg (8lbs)	1...2	160...180 °C	18...20 min. per 450 g
Poultry - up to 5.5 kg (12lbs)	1...2	150...160 °C	14...16 min. per 450 g
Casseroles	1...2	140...150 °C	90...120 min. [§]
Fruit cake	2 ... 3	130...140 °C [#]
Small cakes	4	160...180 °C	15...25 min.
Victoria sandwich	1	160...180 °C	20...25 min.

[§] depending on quantity/ [#] depending on size

How to operate the top oven part

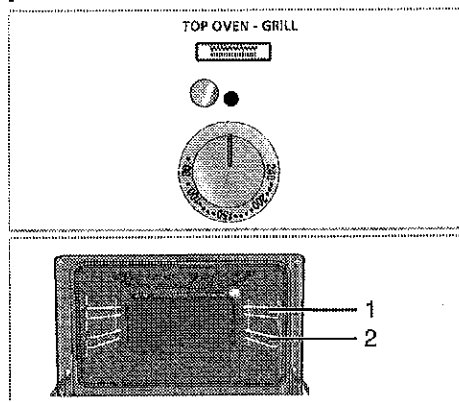

The grill oven can be used as grill or as baking oven. The oven door operates a door switch switching between grill and oven operation.

Switch on oven

The oven is operated by means of the function knob. The oven is switched off if the function knob is in off position (top).

1. Close grill/ oven door.
2. Set oven temperature.

» The temperature lamp is switch off as soon as the set temperature is reached.

Switch off grill oven

1. Turn function knob to off position (top).

Select temperature and operating mode

1. Set the function knob to the desired temperature.
- » The oven will heat up to and keep the set temperature. The thermostat lamp is on during heating up and down.

Switch off electric oven

Turn function knob to off position (top).

Cooking times table

i The values indicated in the table below are data indicative. They may vary according to the type of food as well as your preferences of cooking.

Baking and roasting for top oven

i Level 1 is the **bottom** level in the oven.

Food	Insertion level	Temperature	Cooking time (approx.)
Beef	1	170...180 °C	30 min. per 450 g + 30 min.
Lamb	1	180...190 °C	30 min. per 450 g + 30 min.
Pork	1	170...190 °C	40 min. per 450 g + 30 min.
Poultry	1	170...190 °C	25...00 min. per 450 g + 25 min.
Casseroles	1	140...160 °C	90...120 min. ^s
Fruit cake	1 ... 2	140...160 °C ⁿ
Small cakes	2	160...180 °C	20...25 min.
Victoria sandwich	1	160...180 °C	20...25 min.

^s depending on quantity / ⁿ depending on size

How to operate the grill -Top oven

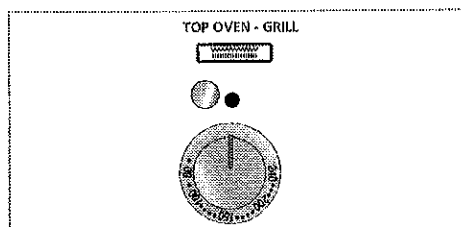

i Do not use the upper level for grilling.

The grill oven can be used as grill or as baking oven. The oven door operates a door switch switching between grill and oven operation.

Switch on grill

The grill is operated by means of the function knob. The grill is switched off if the function knob is in off position (top).

1. Open grill/ oven door.
2. Set grill temperature to 150 °C and preheat for around 5 minutes, if it is necessary.
3. Then set desired grill temperature.
» The thermostat lamp is switched on.

Switch off grill oven

1. Turn function knob to off position (top).
 - Put big or medium-sized portions in correct shelf position under the grill heater for grilling.
 - Food which requires browning only should be placed under the hot grill, either in the grill pan, or on the floor of the grill compartment, according to the depth of the dish. The grill pan wire grid can be removed.
 - Plates and dishes placed on the floor of the grill compartment will be heated when main oven is in use.
 - Do not switch on the grill when using the compartment for storage.

Top oven cooking times table for grilling

i Do not use the upper level for grilling.

Baking and roasting

i Level 1 is the **bottom** level in the oven.

Food	Insertion level	Temperature	Cooking time
Roast beef	1	170...180 °C	30 min. per 450 g + 30 min.
Roast lamb	1	180...190 °C	30 min. per 450 g + 30 min.
Roast pork	1	170...190 °C	40 min. per 450 g + 40 min.
Poultry	1	170...190 °C	25...30 min. per 450 g + 25 min.
Casseroles	1	140...160 °C	90...120 min. [§]
Fruit cake	1...2	140...160 °C [#]
Small cakes	2	160...180 °C	20...25 min.
Victoria sandwich	1	160...180 °C	20...25 min.

[§] depending on quantity / [#] depending on size

How to use the alarm clock

In addition to using the timer for cooking, it can be also used as a reminder or an alarm clock.

As soon as the defined period of time has expired, the alarm clock will emit a signal. The alarm clock has no influence on the functions of the oven.

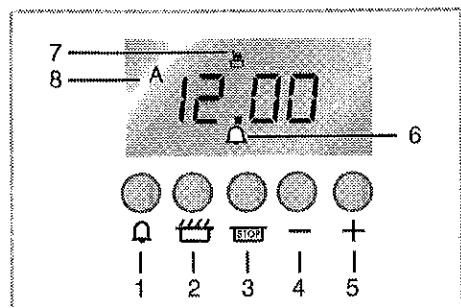

Keys for:

- 1 Alarm clock
- 2 Cooking time
- 3 End of cooking time

Keys for time adjustment:

- 4 Minus key
- 5 Plus key

Display symbols for:

- 6 Alarm clock
- 7 Cooking
- 8 Automatic

Setting the alarm clock

1. Keep key **1** pressed.

i The maximum alarm time can be 23 hours and 59 minutes.

2. With key **4** or key **5** you can set the period of time which is to elapse before the alarm signal sounds. By pressing the key shortly, you advance or reset the clock by one minute. When you keep the key pressed, the minutes are advanced or reset quickly.

» The alarm clock symbol on the display lights up.

3. Release key **1**.

i When you press key **1** while the alarm clock is activated, the display will show the remaining cooking time for a short moment.

Switching off the alarm

1. Press key **1** when the alarm is sounded and the alarm clock symbol disappears.

In order to cancel set alarm time;

1. To reset the alarm time, keep key **1** pressed.
2. Keep key **4** pressed until "0.00" is shown as remaining time on the display.
 - » The alarm clock symbol in the display disappears and an alarm is sounded.
3. Release key **1**.

7 Maintenance and care

General information

-  Risk of electric shock!
Switch off the electricity before cleaning appliance to avoid an electric shock.

-  Hot surfaces may cause burns!
Allow the appliance to cool down before you clean it.

-  The surface may get damaged by some detergents or cleaning materials.
Do not use aggressive detergents, cleaning powder/cream or any sharp objects.

Clean the appliance thoroughly after each use; in this way it will be possible to remove cooking residues more easily, thus avoiding these from burning the next time the appliance is used.

No special cleaning agents are required for cleaning the appliance. It is recommended to use warm water with washing liquid, a soft cloth or sponge and use a dry cloth for drying.

Do not use any abrasive cleaning materials!

-  Do not use steam cleaners for cleaning.

How to clean the hob

Ceramic hobs

Always rinse off fully with a clean cloth wrung out in clean water (as residue could damage the ceramic glass surface next time the hob is used).

In no case should crusts be scratched off with serrated edge knives, steel wool or the like.

Remove calcium stains (yellow staining) with small amounts of decalcifying agents such as Durgol, vinegar or lemon juice.

Apply agent with a sponge and, in the event of heavier soiling, let it work in for a longer period of time. Afterwards, wash off/hob with water.

-  Sugar-based food such as custard and syrup should immediately be scraped off without waiting for the surface to cool down. Otherwise the hob may be permanently damaged.

Cleaning the control panel

-  Damage of the control panel!
Do not remove the control knobs for control panel cleaning.

Clean control panel and control knobs.

Cleaning the oven

No oven cleaner or any other special cleaning agent is required for cleaning the oven. It is recommended to wipe the oven with a damp cloth while it is still warm.

To clean the side wall, unscrew the 4 screws on the steel rack. After

cleaning operation, assemble the steel rack to the oven body again.

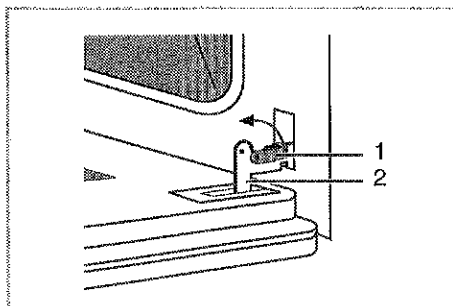
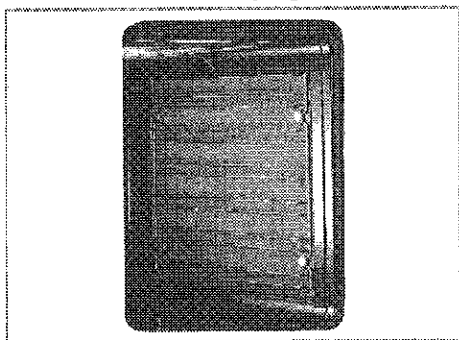

- 1 Hinged shackles
- 2 Hinge

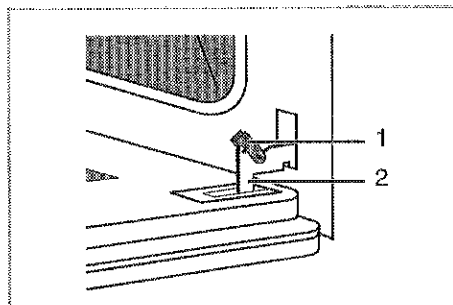

3. Put oven door in a slightly sloping position.
 4. Lift the oven door to the front with both hands.
- Install oven door again in reverse order after cleaning.

Catalytic walls

Side walls or just back wall of oven interior may be covered with catalytic enamel.

The catalytic walls of the oven must not be cleaned. The porous surface of the walls is self-cleaning by absorbing and converting spitting fat (steam and carbon dioxide).

Clean oven door

Don't use any harsh abrasive cleaners or sharp metal scrapers for cleaning the oven door. They could scratch the surface and destroy the glass.

Removal of oven door

The top oven door can be disassembled for easier cleaning of the inner space of the oven.

1. Open oven door entirely.
2. Press hinged shackles back at both sides.

Replacing the oven lamp

- ⚠** Hot surfaces may cause burns! Make sure that the appliance is switched off and cooled down in order to avoid the risk of an electrical shock.

The oven lamp is a special heat-resisting (T 300 °C) electric light bulb; see *Technical Data, page 5*. Oven lamps can be obtained from a good local electrical store.

- ⓘ** Position of lamp may vary from diagram.

1. Switch off the appliance at the mains.

2. Unscrew glass cover by turning anti-clockwise.

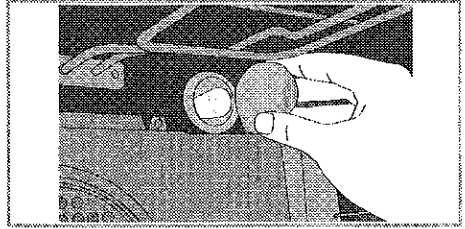

3. Unscrew oven lamp by turning anti-clockwise and replace it with new one.
4. Refit the glass cover.

8 Troubleshooting

-  Risk of electric shock, short circuit or fire by unprofessional repairs!
Repairs on the appliance must be carried out by an approved service centre.

- It is normal that steam escapes during operation.
- When the metal parts are heated, they may expand and cause noise.

Before you call the service, please check the following points.

Normal operating conditions

- Smoke and smell may emit for a couple of hours during the first operation.

Electrical equipment

Malfunction/problem	Possible cause	Advice/remedy
The appliance does not work.	The mains fuse is defective or has tripped.	Check fuses in the fuse box. If necessary, replace or reset them.
Oven light does not work	Oven lamp is defective.	Replace oven lamp.
	No current.	Check fuses in the fuse box. If necessary, replace or reset them.
Oven does not heat.	Function knob and/thermostat knob are not set.	Set function knob and thermostat knob.
	If the appliance has a timer, the timer may not be set.	Set the time.
	No power.	Check mains supply and fuse box.

Clock/ timer (If the appliance has a digital timer)

Malfunction/problem	Possible cause	Advice/remedy
Clock display is blinking or clock symbol is on.	Power was interrupted previously.	Set time Then switch the oven off with function knobs, set the oven function again.

If the problem has not been solved:

1. Separate unit from the mains supply (deactivate or unscrew fuse).
2. Call the after-sales service of your store reseller.

-  Do not attempt to repair the appliance yourself. There are no customer service items inside the appliance.

ELECTRICAL DISTRIBUTORS AUSTRALIA PTY LTD

ABN 11 051 297 557

SUITE 8/92A MONVALE ROAD (Enter of Daydream street) WARRIEWOOD
NSW 2102

PH: 02 9999 2124 FAX: 02 9999 1684

EMAIL: EDAAUST@bigpond.com web site www.euromaid.com.au

EUROMAID COOKER WARRANTY IN ADDITIONS TO RIGHTS BY LAW

Electrical Distributors Australia Pty Ltd guarantees to the original purchaser subject to model type either 12 months or Two Years of ownership that any part with defective material be replaced free of charge, provided that all service work is carried out by Electrical distributors Australia Pty Ltd or the nearest appointed service agent.

2 Year Warranty Products:

All built in appliances such as Ovens, Gas and Electric Cook tops.

1 Year Warranty Products:

All Free Standing Gas and Electric products including bench top and portable products.

Portable products ie MC110T are to be returned to the nearest service agent by the purchaser these products offer no in home warranty repair.

Where the appliance is installed outside the normal service area of Electrical Distributors Australia Pty Ltd or its Appointed Service Agent the purchaser will pay the travel cost charges for the service agent to attend the repair or to take the appliance to the service centre.

Built In & Free Standing Appliances:

Access must be granted within normal working hours and our Service Agents must have easy access to these built in Appliances and charges will be the responsibility of the purchaser where the service technician cannot obtain easy access to remove the appliance for inspection prior to repair.

This Warranty is not transferable and excludes any repair or replacement caused by Power Surges faulty installation abuse, Pest Damages, misuse, acts of God or accident.

The above Warranty is for Domestic Application only and is limited to Three (3) Months in Commercial Applications.

FOR SERVICE OUTSIDE THE ABOVE AREAS PLEASE CONTACT HEAD SYDNEY OFFICE PH: 02 9999 2124

AUTHORISED SERVICE AGENTS:

NSW

ALL GENERAL WHITEGOODS
4/11 HALLSTROM PLACE
WETHERILL PARK 2164 NSW
PH: 02 97561511
FAX: 02 97561091

GOLD COAST

ROSHAD APPLIANCE SERVICE
1/13 LEDA DRIVE
BURLEIGH QLD 4220
PH: 0755357044
FAX: 0755357407

QUEENSLAND

ENDEAVOUR REFRIGERATION
167 ROBERTSON STREET
FORTITUDE VALLEY QLD 4006
PH: 07 3137 3633
FAX: 07 3137 3663

VIC

ALL STOVE SERVICE
73 HAVERSHAM AVE
WHEELER HILLS VIC 3150
PH: 1800631348
MOBILE: 0418367468

TASMANIA

FARR ELECTRICAL
286 MAC QUARIE STREET
SOUTH HOBART TAS 7004
PH: 03 6223 1010
FAX: 03 6223 7039

WESTERN AUSTRALIA

DACAP UNIT
4/57 KENT STREET
CANNINGTON WA 6107
PH: 08 9358 6033 FAX: 08 9358 6044
PERTH

SOUTH AUSTRALIA

PRESTIEGE APPLIANCE REPAIRS CENTRE
4/65 STEPHENS AVENUE
TORRENSVILLE SOUTH AUSTRALIA 5031
PH: 08 83522022
FAX: 08 83522044