



Installation and Instructions for Use

BSD069



Baumatic





SAFETY INSTRUCTIONS

Read this Instruction Manual carefully to obtain the best performance from your oven. Keep this manual so that it can be read by a new owner.

Electrical Safety

- To connect the oven to the power supply, the technician should use an T150 power cable. The connection diagram is shown in Figure 19.
- The oven should always have a good earth connection in line with current regulations.
- Connection must be made by means of an omnipolar switch that is suitable for the current drawn and with a minimum aperture between contacts of 3 mm for disconnection in case of emergency, cleaning or bulb changing. Under no circumstances must the earth wire pass through this switch.
- This switch may be replaced by a plug, provided it is accessible for normal use.
- If the supply cord is damaged, it must be replaced by the manufacturer, its service agent or similarly qualified persons in order to avoid a hazard.
- Any handling or repair to the appliance, including replacement of the power cable, should be carried out by authorised Technical Service Personnel using original spare parts. Repairs or handling by others may damage the appliance or cause malfunctioning that could be hazardous to your safety.
- Unplug your oven if it malfunctions.

- In ovens combined with hobs, only those recommended by the manufacturer may be fitted.

Child Safety

During use, the appliance becomes hot. Care should be taken to avoid touching heating elements inside the oven.

WARNING: Accessible parts may become hot during use. To avoid burns, young children should be kept away. Accessible parts may become hot when the grill is in use. Children should be kept away.

WARNING: This appliance is not intended for use by persons (including children) with reduced physical, sensory or mental capabilities, or lack of experience and knowledge, unless they have been given supervision or instruction concerning use of the appliance by a person responsible for their safety. Children should be supervised to ensure that they do not play with the appliance.

Safety in the use of the oven

- The oven must always be operated with the door closed.
- Only use the oven after it has been installed inside the kitchen unit (See Installing the Oven).
- The tray and grill have a system for easy part removal and handling of food.
- The oven heats up when in use, so please use oven gloves when performing operations inside the oven and avoid touching the heating elements.

- Only use the temperature probe supplied to measure the temperature inside the oven (in models that come with this feature).



Cleaning and Maintenance

- Disconnect the appliance from the mains power supply before any operation.
- Do not use abrasive cleaning products, or steam or pressurised water cleaning equipment.
- Cleaning and maintenance tasks to be carried out by the user should not be done by children without supervision.
- Before replacing a bulb, first make sure that the oven has been disconnected from the mains to avoid the possibility of receiving an electric shock.



Before First Use

There may be traces of grease and other substances in the oven as a result of its manufacturing process. These should be removed by means of the following procedure:

- Remove all of the packaging from your oven, including the protective plastic, if any.
- Turn the oven to setting , or else place it on the defect setting , at 200°C, for 1 hour. Consult the Quick Start Guide accompanying this manual on how to do this.
- Cool the oven with the door open so that it ventilates and no odours remain inside it.
- Once cold, clean the oven and accessories.

During this first operation, smoke and smells will be produced. The kitchen should therefore be well ventilated.

Environmentally Friendly Packaging

The packaging is made from totally recyclable materials which can be put to other uses. Consult your local council regarding the necessary procedures for disposing of these materials.

CAUTION

The  symbol on the product or packaging indicates that this appliance cannot be disposed of as normal household waste. It should be taken to an electrical and electronic equipment collection point for recycling. In this way, any negative consequences for the environment and public health from incorrect handling can be avoided. Contact your local council, household waste disposal service or the establishment you bought the product from for more information on recycling the appliance.

Other important instructions

- The oven must always be operated with the door closed.
- The manufacturer takes no responsibility for any use of the oven other than for the home preparation of food.
- Do not store oil, fats or inflammable materials inside the oven. This may be dangerous if the oven is turned on.
- Do not lean or sit on the open oven door. You could damage it, as well as endanger your own safety.
- Do not cover the bottom of the oven with aluminium foil as this may affect cooking performance and damage the enamel inside the oven and the interior of your kitchen unit.
- To cook any food, insert the tray or grill in the side rails in the oven.
- Do not place containers or food on the bottom surface of the oven. Always use the trays and grill.
- Do not pour water on the bottom surface of the oven when in use; this may damage the enamel.
- Open the oven door as little as possible during cooking. This will reduce power consumption.
- It is normal for condensation to occur on the oven door when cooking dishes with a high liquid content.
- Clean the oven interior to remove traces of grease or food, which could later give off smoke and odours and cause stains to appear.



Cleaning and Maintenance

Caution:

Disconnect the appliance from mains power supply before any operation.

Cleaning the Oven Interior

1 Easy-to-clean enamel ovens

Use nylon brushes or sponges with warm soapy water to clean enamelled surfaces such as the bottom of the oven. Clean when the oven is cold. Use oven-cleaning products only on enamelled surfaces and always follow the manufacturer's instructions.

2 Ovens coated in special enamel adapted to other cleaning systems

Please consult the Specifications Sheet for your oven.

Caution

Do not clean the oven interior with steam or pressurised water cleaning equipment. Do not use metal scouring pads, wire brushes or any utensil that can scratch the enamel.

- Other oven models have a catalytic (self-cleaning) cleaning system. This system removes small traces of grease while cooking at high temperatures.

Use of Fold-down Grill (depending on Model)

To clean the top part of the oven:

- Wait until the oven is cold.
- Turn the screw (A) and lower the grill element as far as possible. Figure 1
- In other oven models, push the rod of the grill element (B) with both hands until it is released from the upper fastening point. Figure 2
- Turn the element round and clean the upper part of the oven.
- Finally, return the grill element to its original position.

Cleaning the Oven Exterior and Accessories

Clean the outside of the oven and accessories with warm soapy water or with a mild detergent. Take great care when cleaning stainless steel surfaces. Use only sponges or cloths that do not scratch.

Cleaning the Oven Door

Do not use metal scouring pads, wire brushes or commercially available or abrasive powder cleansers to clean the oven door as they could scratch the surface and cause the glass to break.

In some oven models the door may be removed to make them easier to clean, by proceeding as follows:

- 1 Open the door.
- 2 Turn the two clamps (F) right round. Figure 6
- 3 Close the door until it fits in the two clamps. Figure 7
- 4 Holding the door at the sides with both hands, raise and remove the door from the oven until the hinges (G) have been completely removed. Figure 8

To mount the door, proceed in reverse order.

For other oven models, follow these instructions:

- 1 Open the oven door completely.
- 2 Insert the safety pins in the visible slots in the door hinges. Figure 9
- 3 Hold the door at the sides with both hands and close it almost completely.
- 4 Now lift the door and remove the hinges from the slots in the front of the oven by pulling them out. Figure 8

Caution

Do not remove the safety pins at any time since the hinge is taut and may cause injury. It would also be impossible to mount the door without the pins being in place.

To mount the door, hold it with both hands and insert the hinges in the appropriate openings in the front of the oven. Slowly open the door until it is fully open.

Cleaning the Large Inner Glass Door

Instructions for Removing / Replacing Inner Glass

- 1 Open the oven door.
- 2 Pull the glass outwards by the bottom (H).
Figure 10
- 3 The inside glass will become loose.
Remove it.

Caution

Be very careful when removing the inner glass, as the oven door will close.

- 4 Clean the inner glass and the inner surface of the oven door.
- 5 Return the glass supports to the upper door slots (I). Figure 11
- 6 Turn the glass towards the door (K).
- 7 Attach the glass to the door again by pushing the two lower supports (L) with both hands while pushing the glass towards the door (M). Figure 12

Warning

If the door has not been blocked with the clamp (N), please take care when removing the inside glass panels as the oven door will close.

- 6 Once clean, return the glass panels in the same order so that the word **TERMOGLASS** can be read.
- 7 Replace the upper clasp of the door, making sure that the side tabs fit in point 1.

Changing the Oven Light bulb

Caution

First make sure the oven is unplugged before proceeding to change the bulb.

Warning

Ensure that the appliance is switched off before replacing the lamp to avoid the possibility of electric shock.

- Unscrew the bulb-holder glass cover.
- Replace the bulb and reassemble the glass cover.

The replacement bulb must be resistant to temperatures up to 300°C. You can order one from the Technical Assistance Service. Figure 16

For other oven models, follow these instructions:

- Loosen the lens from the lampholder with the help of the appropriate tool. Fig 17
- Exchange the bulb.
- Replace the lens, making sure it fits in the correct position without forcing it. Fig 18

If Something Goes Wrong Technical Specifications

The oven stops working
<p>Check the power connection.</p> <p>Check the fuses and the circuit breaker for your installation.</p> <p>Make sure the timer is either in the manual or programmed setting.</p> <p>Check the position of the function and temperature setting.</p>
The light inside the oven does not go on
<p>Change the bulb.</p> <p>Check that it has been properly inserted according to the Instruction Manual.</p>
The heating pilot light does not turn on
<p>Select a temperature.</p> <p>Select a function.</p> <p>It should only come on while the oven is heating up to the temperature selected.</p>
Oven smoking during use
<p>Normal during first use.</p> <p>Clean the oven regularly.</p> <p>Reduce the amount of grease or oil in the tray.</p> <p>Do not use temperatures higher than those indicated in the cooking chart.</p>
The expected cooking results are not achieved
<p>Check the cooking chart for guidance on how your oven operates.</p>

If the appliance does not work, inform Technical Service of the kind of problem you are experiencing and give the:

- 1** Serial Number (S-No)
- 2** Model of Appliance (Mod.)

You will find this information engraved on the identification plate. This plate is on the bottom of the oven and can be seen when opening the door.

Installation

This information is exclusively for the installer, who is responsible for the oven's assembly and electrical connection. If you install the oven yourself, the manufacturer will not accept liability for possible damage.

Prior to Installation

Please refer to electrical safety instructions on page 3 of this manual before installation.

- The opening in the kitchen unit must be that indicated on the diagram. The minimum size of the unit base must be 580 mm. (See Figures 16, 17, 18 and 20).
- The adhesive used in the plastic lining the kitchen units must be able to withstand temperatures over 85°C.

Caution

If these problems persist despite these tips, contact Technical Service.



Electrical Connection

The installer must ensure that:

- The mains power voltage and frequency correspond to what is marked on the identification plate.
- The wiring system can withstand the maximum power marked on the identification plate.
- After connecting the power, check that all electrical parts of the oven are working correctly.
- Disconnection from the electrical supply must be allowed after the oven is in the installed position.

Oven Installation

For all ovens, after the power has been connected:

- 1** Position the oven inside the unit and ensure that the power cable is not trapped or in contact with parts of the oven that heat up.
- 2** Anchor the oven to the unit with the screws supplied, screwing them into the unit through the holes that can be seen when the door is open.
- 3** Make sure that the body of the oven is not in contact with the walls of the unit and that there is a separation of at least 2 mm with the adjacent units.





Control Panel

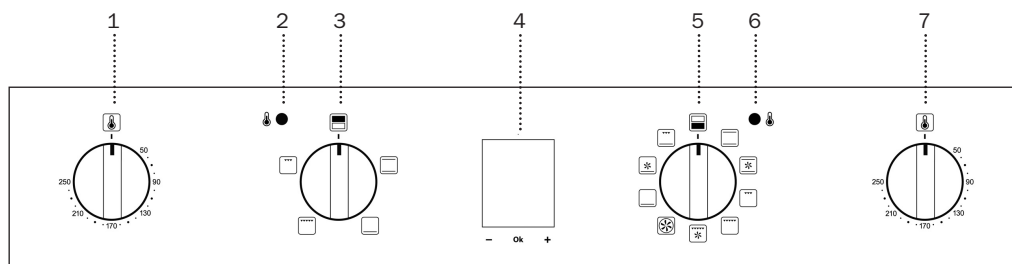

Top cavity

- 1 Temperature selector.
- 2 Heating indicator light. Indicates that the heat is going to the food and it goes out when the set temperature is reached.
- 3 Function selector.

Main cavity

- 4 Electronic clock.
- 5 Function selector.
- 6 Heating indicator light.
- 7 Temperature selector.

Oven Functions

Top cavity: / / / /

Main cavity: / / / / / / /

Switch off oven

Conventional

It is used for sponges and cakes where the heat received must be uniform to achieve a spongy texture.

Conventional with fan

Appropriate for roasts and cakes. The fan spreads the heat uniformly inside the oven.

Lower Element

Heats only from beneath. Suitable for heating dishes and raising pastry and similar.

Lower element with fan

It distributes the heat from the lower part of the oven and is ideal for cakes with jam or fruit filling, which only require heating from beneath. Pre-heating is always necessary.

MaxiGrill

Allows greater surfaces to be prepared, than with the grill, together with higher power reducing the time required for browning of the food.

Caution

When MaxiGrill function is active in top cavity, the temperature selected can't be over 220°.

Grill

For preparing dishes with superficial roasting. It allows the outer layer to be browned without affecting the inside of the food. Ideal for flat food, such as steaks, ribs, fish, toast.

MaxiGrill with fan

Allows uniform roasting at the same time as surface browning. Ideal for grills. Special for large volume pieces, such as poultry game etc. It is recommended to put the item on a rack with a tray beneath to collect the stock and juices.

Caution

While using the Grill, MaxiGrill or MaxiGrill with fan, the door must be kept closed.



**Grill and Lower element**

Special for roasts. It can be used for any piece, whatever its size.

**Turbo**

The fan distributes the heat produced by an element located at the rear of the oven. Due

to the uniform heat distribution, it allows roasting and baking to take place on two levels at the same time.

Note

The pilot light remains on in any cooking function.

Use of the Oven

Caution

The electronic clock features Touch-Control technology. To operate, simply touch the glass control symbols with your fingertip.

The touch control sensitivity continuously adapts to ambient conditions. Make sure the glass surface of the control panel is clean and free of obstacles when plugging in the oven.

If the clock does not respond correctly when you touch the glass, unplug the oven for a few seconds and then plug it in again. Doing this causes the sensors to adjust automatically so that they will react once more to fingertip control.

Setting the time on the Electronic Clock

When the oven is connected to the power supply, the indication 00:00 flash on the display. Press **-** or **+** to set the time on the clock. The clock beeps twice to confirm the selected time.

If you wish to modify the time, press **-** or **+** until the current time flash on the screen. Press **OK**. Then press **-** or **+** to modify the time. The clock beeps twice to confirm the modification.

Manual Operation

The oven is ready to be used when the clock has been set. Select a cooking function and a temperature.

When you begin cooking, symbol  lights up to indicate that the oven is heating the contents; the symbol goes out when the selected temperature is reached.

Set the controls to  to turn the oven off.

Functions of the Electronic Clock





Alarm: Creates an alarm signal when the period of time finishes; the oven does not need to be in use in order to use this function.

Cooking Time: To cook for a selected length of time; the oven turns itself off automatically when the time finishes.

End Cooking Time: To cook until a set time; the oven turns itself off automatically when the time finishes.



Cooking time and End Cooking Time: To cook for a selected length of time and end at a set time. When this function is set, the oven comes on automatically at the time required in order to cook for the set length of time (Cooking time) and end automatically at the indicated time (End Cooking Time)

Programming the Alarm





- 1** Press **+** until symbol  lights up. Press **OK**.
- 2** Set the period of time after which you wish the alarm to sound by pressing **-** or **+**.
- 3** The clock beeps twice, the current time is displayed and symbol  lights up permanently to indicate that the alarm has been set.
- 4** When the set period of time comes to an end, the alarm sounds and symbol  starts to flash.
- 5** Press any button to stop the alarm; symbol  goes out.





You can consult the remaining time at any moment by pressing **-** or **+** until symbol  flashes and then pressing **OK**. You can also modify the set time at this point by pressing **-** or **+**. The clock beeps twice to confirm the change.

If you wish the remaining time to be displayed until the end of the set period of time, press **-** or **+** until symbol  flashes and then press **OK** and keep it pressed in. Symbol  flashes. Keep **OK** pressed in again to return to the real time.





Setting the Cooking Time

- 1** Press **-** or **+** until symbol  lights up. Press **OK**.
- 2** Select the period of time you wish to cook for by pressing **-** or **+**.
- 3** The clock beeps twice, the current time is displayed and symbol  lights up permanently to indicate that the oven will turn itself off automatically.
- 4** Select a cooking function and temperature.
- 5** When the cooking time comes to an end, the oven turns itself off, the alarm sounds and symbol  flashes.
- 6** Press any button to stop the alarm and turn the oven back on again.
- 7** Set the controls to  to turn the oven off.

You can consult the remaining cooking time at any moment by pressing **-** or **+** until symbol  flashes and then pressing **OK**. You can also modify the set time at this point by pressing **-** or **+**. The clock beeps twice to confirm the change.

If you wish the remaining time to be displayed until the end of the set period of time, press **-** or **+** until symbol  flashes and then press **OK** and keep it pressed in. Symbol  flashes. Keep **OK** pressed in again to return to the real time.





Setting the End Cooking Time

- 1** Press **-** or **+** until symbol  lights up. Press **OK**.
- 2** Select the time you wish the cooking process to finish at by pressing **-** or **+**.
- 3** The clock beeps twice, the current time is displayed and symbol  lights up permanently to indicate that the oven will turn itself off automatically.
- 4** Select a cooking function and temperature.
- 5** When the set time is reached, the oven turns itself off, the alarm sounds and symbol  flashes.
- 6** Press any button to stop the alarm and turn the oven back on again.
- 7** Set the controls to  to turn the oven off.

You can consult the end cooking time at any moment by pressing **-** or **+** until symbol  flashes and then pressing **OK**. You can also modify the end cooking time at this point by pressing **-** or **+**. The clock beeps twice to confirm the change.

This function can be used even when you are already using the oven. To do this, follow the instructions indicated above except point number 4.

Setting the Cooking Time and the End Cooking Time

- 1** Press **-** or **+** until symbol  lights up. Press **OK**.
- 2** Select the period of time you wish to cook for by pressing **-** or **+**.
- 3** The clock beeps twice, the current time is displayed and symbol  lights up permanently.
- 4** Press **-** or **+** until symbol  lights up. Press **OK**.
- 5** Select the time you wish the cooking process to finish at by pressing **-** or **+**.
- 6** The clock beeps twice, the current time is displayed and symbol  lights up permanently.



- 7 Select a cooking function and temperature.
- 8 The oven remains off with symbols $\rightarrow|$ and $\rightarrow|$ lit up. Your oven is set.
- 9 When the time to start cooking is reached, the oven starts up and cooks for the set period of time.
- 10 When the set end cooking time is reached, the oven turns itself off, the alarm sounds and symbols $\rightarrow|$ and $\rightarrow|$ flash.
- 11 Press any button to stop the alarm and turn the oven back on again.
- 12 Set the controls to \blacksquare to turn the oven off.

You can modify the end cooking time by pressing $-$ or $+$ until symbol $\rightarrow|$ lights up and then pressing **OK**. You can now modify the end cooking time by pressing $-$ or $+$. The clock beeps twice to confirm the change.

Important

In the event of a power cut, all the electronic clock settings are deleted and the indication 00:00 flashes on the display. It is necessary to set the time and programme the clock again.



Child Safety Function

This function can be selected at any time while using the oven.

To activate the function, press the $+$ and $-$ sensors at the same time for several seconds. You will hear a beep and the display will show the word **SAFE**. The clock is locked.

If the oven is off and you activate the child safety function, it will not work even if a cooking function is selected.

If this function is activated while you are cooking, it will only lock the electronic clock settings.

If a clock sensor is touched while the child safety function is on, the word **SAFE** will appear on the display. The clock is locked.

To disable the function, press the $+$ and $-$ sensors at the same time for several seconds until you hear a beep.

Shelf positions

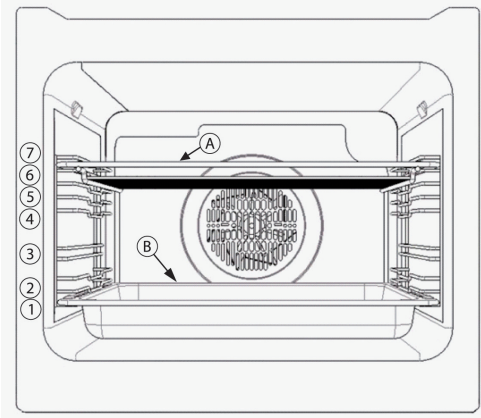

Your oven will come supplied with the following oven furniture:

(A) Oven shelf

(B) Enamelled deep tray

The numbers 1 – 7, indicate the different shelf positions that you can utilise within the oven.

(Image for reference only – actual product may differ slightly)

You should use the shelf position(s) that you find are best suited to your personal cooking preferences.

Insert the oven shelf and deep tray between the 2 side rails at any position (1 to 7) on both sides. The oven shelf has safety stops to prevent accidental withdraw. After engaging the oven shelf into the side rails, as you push the oven shelf into the oven, lift the front of the shelf slightly to bypass the stops and allow the oven shelf to slide fully into the rails.

To remove the oven shelf, gently pull the oven shelf outwards. When the shelf stops, lift the front slightly to bypass the safety stops and then completely withdraw the oven shelf from the oven.

When installed correctly, the shelf and tray should be horizontal and not on an angle.



Figures

Fig 1

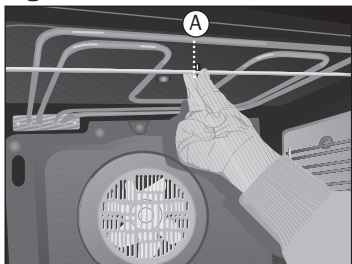

Fig 2

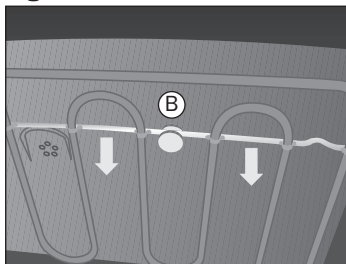

Fig 3

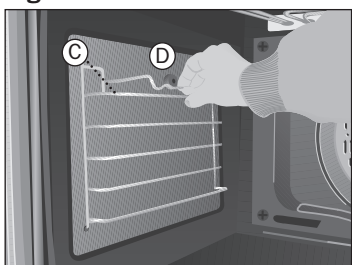

Fig 4

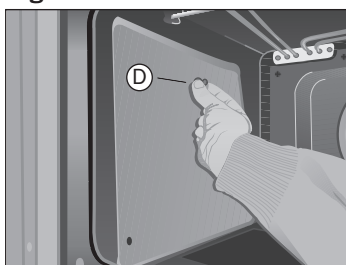

Fig 5

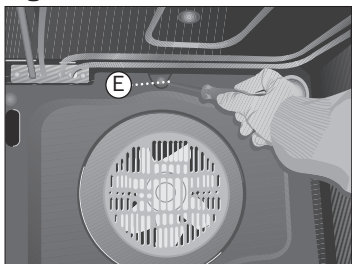

Fig 6

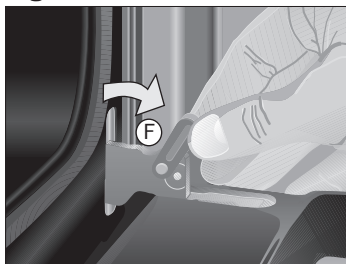

Fig 7

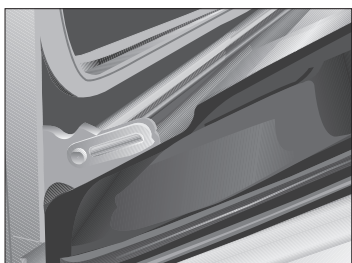

Fig 8

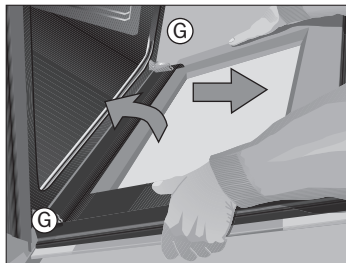



Fig 9

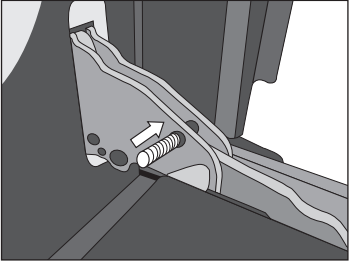

Fig 10

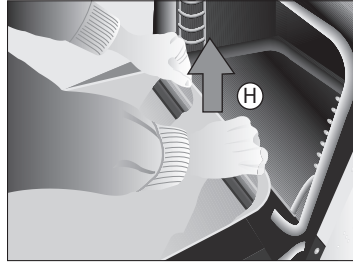

Fig 11

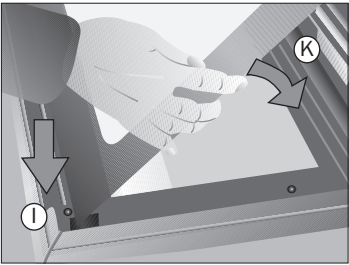

Fig 12

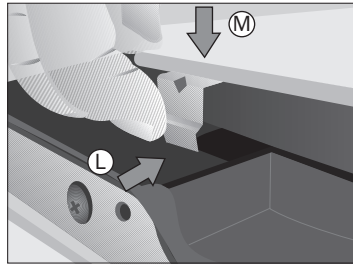

Fig 13

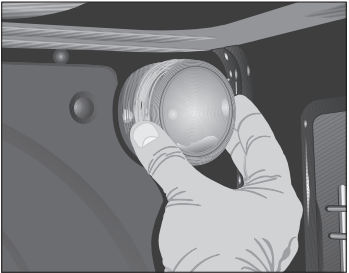

Fig 14

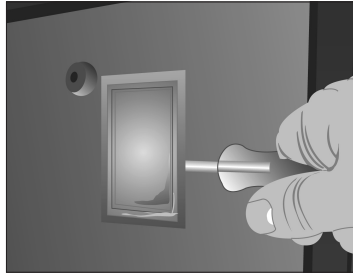
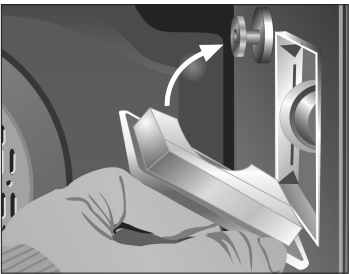

Fig 15



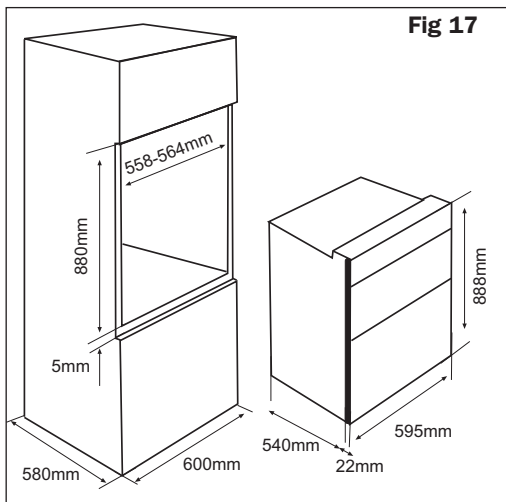
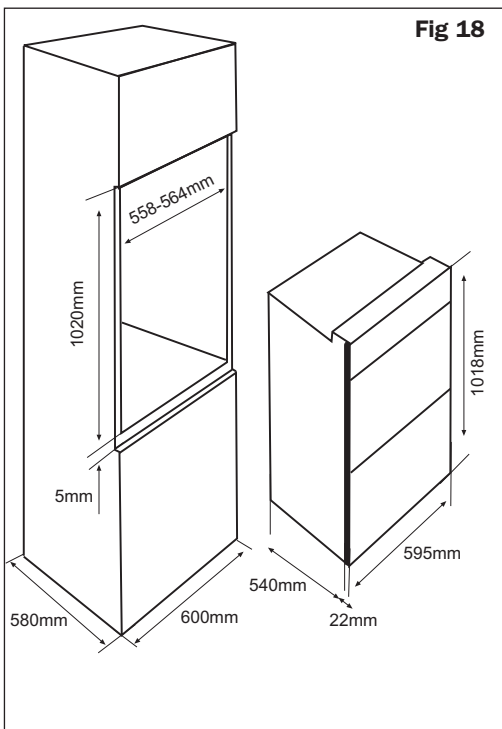
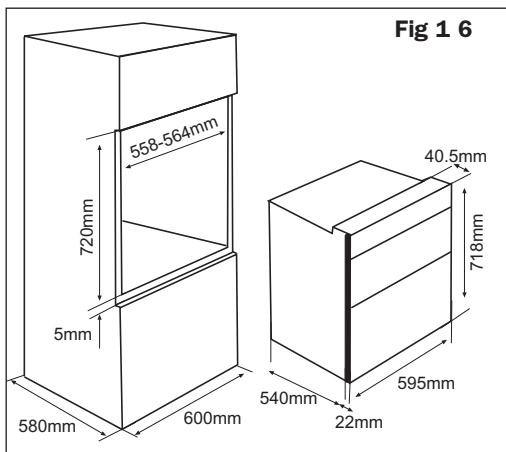
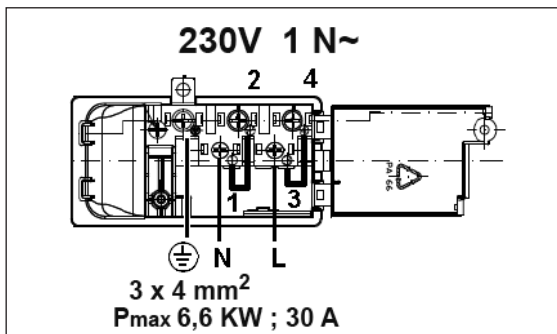
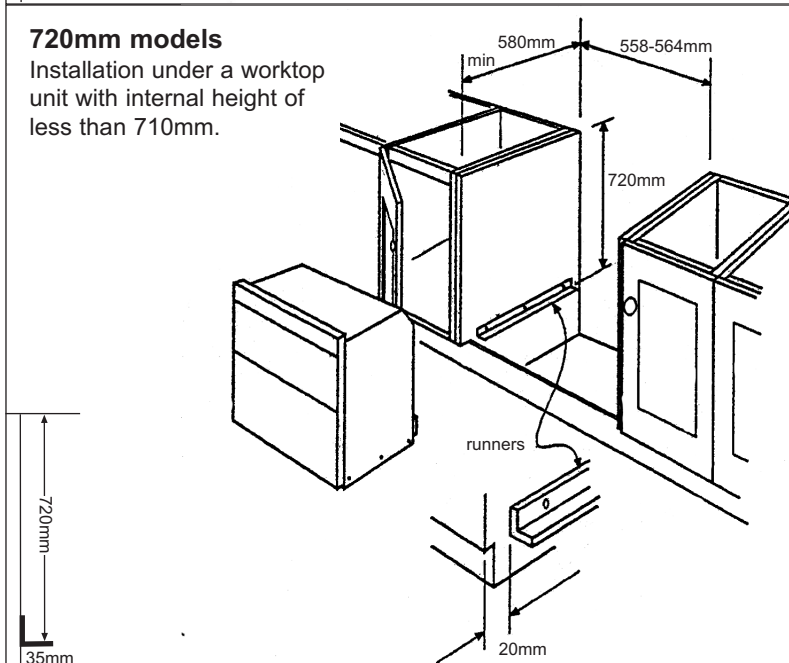
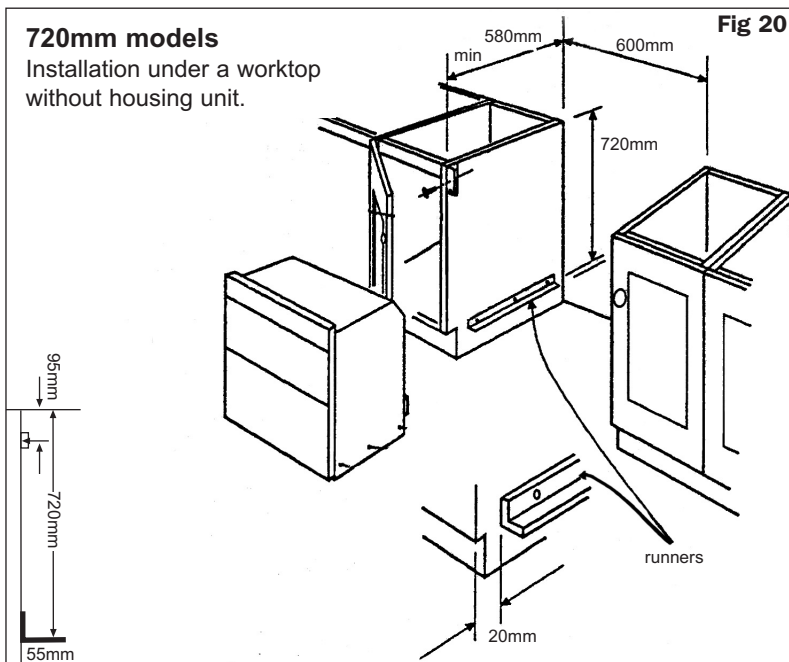

Fig 19







Baumatic®

(AUS)

Home Appliances

20 Carlotta Street
Artarmon 2064

Service Telephone

1800 444 357

Website

www.baumatic.com.au

Our contribution to environmental protection: we use recycled paper.
Cod.: 83172609/3172609-005

