

# HEATSTRIP<sup>®</sup>



## OPERATION, INSTALLATION AND MAINTENANCE MANUAL

Wall Mounted Radiant Gas Heater

TGH34WN (Natural Gas)

TGH34WL (ULPG)

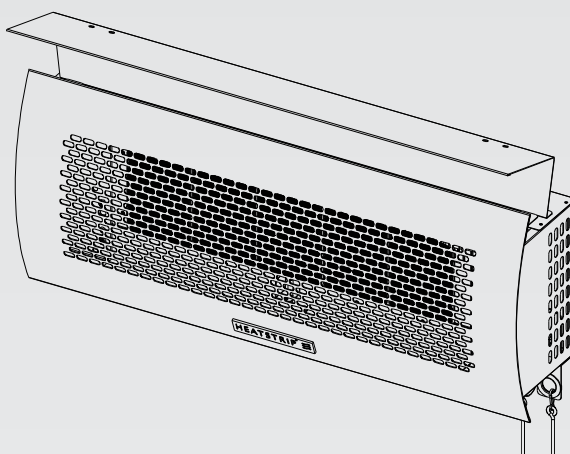

### **DANGER**

If you smell gas:

1. Shut off gas to the appliance.
2. Extinguish any open flame.
3. If odor continues, keep away from the appliance and immediately call your gas supplier or your fire department.

### **DANGER**

Do not store or use flammable liquids or vapors in the vicinity of this appliance.

### **WARNING**

Improper Installation, adjustment, alteration, service, or maintenance can cause property damage, injury or death. Read this operating and assembly instruction thoroughly before installing or serving this heater.

### **WARNING**

**FOR OUTDOOR AND NON-RESIDENTIAL INDOOR USE ONLY.**

**THIS APPLIANCE MUST NOT BE INSTALLED OR USED IN RESIDENTIAL DOMESTIC INDOORS.**

*Appliance is to be protected from rain.*

**TO BE INSTALLED ONLY BY AN AUTHORIZED PERSON.**



## Table of Contents

Primary Safety Warnings.....	3-5
Product Preview.....	7
Part Diagrams and Lists.....	8-10
Installation Instructions.....	11-12
Use and Care Instruction.....	13
Lighting Instruction.....	14
Troubleshooting.....	15
Cleaning and Maintenance.....	15
Warranty Terms.....	Back Cover

### For the repair or replacement parts

You need to contact Thermofilm Australia Pty Ltd  
17 Johnston Court, Dandenong South, Victoria 3175, Australia  
Telephone: (03) 9562 3455  
8:30am-5:00pm Mon-Fri (EST)  
Email: [info@thermofilm.com.au](mailto:info@thermofilm.com.au)

To obtain the correct replacement parts for your gas radiant heater, please refer to the part numbers in this parts list. The following information is required to ensure you receive the correct parts:

1. Model and Serial Number (see label on the heater)
2. Part Number
3. Part Description
4. Quantity of parts needed

**Important:** Use only Thermofilm replacement parts. The use of any part that is not a Thermofilm replacement part can be dangerous and void your product warranty. Keep this Instruction Manual for convenient referral and for part replacement.



## WARNING



1. This appliance must be used only for outdoor and non-residential indoor use. This appliance must not be installed or used in residential indoor areas. This appliance shall only be used in an above ground open-air situation with natural ventilation, without stagnant areas, where gas leakage and products of combustion are rapidly dispersed by wind and natural convection.
2. Any guard or other protective device removed for servicing (conducted by an authorized person) must be replaced before operating the heater.
3. Children and adults should be alerted to the hazards of high surface temperatures and should stay away to avoid burns or clothing ignition.
4. Children should be carefully supervised when they are in the area of the heater.
5. Clothing or other flammable materials should not be hung from the heater or placed on or near the heater.
6. Do not perform maintenance until heater has been turned off, and heater has cooled to room temperature.
7. Do not expose the burner to water or moisture. The appliance must be protected from rain.
8. Do not use the heater if any of these parts are exposed to water until the appliance is inspected or repaired by an authorized service person.
9. The installer is to ensure that the requirements of the local authority, local gas fitting regulations, municipal building codes, and any other relevant statutory regulations are carried out.
10. Certain materials or items, when stored under or near the appliance, will be subjected to radiant heat and could be seriously damaged.
11. All leak tests should be done with a soap solution. Never use an open flame to check for leaks.
12. Do not use the heater until all visible gas connections have been leak tested. Never test for leaks with an open flame. Prior to first use, at the beginning of each season.
13. The radiant heater is NOT intended to be installed on recreational vehicles or boats.
14. Do not attempt to alter the unit in any manner.
15. Do not paint any surface of the heater or reflector.



## WARNING



16. Burner and circulation air passageways of the heater must be kept clean. Frequent cleaning may be required as necessary.
17. Check the heater immediately if any of the following occurs:
  - The heater does not reach temperature.
  - The burner makes popping noise during use (a slight noise is normal when the burner is ignited or extinguished).
18. This appliance is not intended for use by young or infirm person unless they have been adequately supervised by a responsible person to ensure that they can use the appliance safely.
19. Check for damage to the appliance regularly. If damage to the appliance is suspected, discontinue use immediately and contact the supplier or qualified person for repair.
20. Avoid inhaling fumes emitted from the heater's first use. Smoke and odour from the burning of oils used in manufacturing will appear. Both the smoke and odour will dissipate after approximately 30 minutes.
21. Storage of an appliance indoors is permissible only if the cylinder is disconnected and removed from the appliance.
22. Do not store a spare LP gas cylinder under or near this appliance.
23. The heater head angle retaining pin must be inserted if transporting the heater to ensure no damage occurs during transit.
24. Do not install in very windy locations. Do not transport or move the heater while it is operating.

# OUTDOOR AREAS SAFTY APPLIANCE LOCATIONS

This appliance is for outdoor and non-residential indoor use only.

This appliance must not be installed or used in residential indoor areas.

This appliance shall only be used in an above ground open-air situation with natural ventilation, without stagnant areas, where gas leakage and products of combustion are rapidly dispersed by wind and natural convection.

Any enclosure in which the appliance is used shall comply with one of the following:

1. An enclosure with walls on all sides, but at least one permanent opening at ground level.
2. Within a partial enclosure that includes an overhead cover and no more than two walls.
3. Within a partial enclosure that includes an overhead cover and more that two walls, the following shall apply:
  - At least 25% of the total wall area is completely open.
  - At least 30% of the remaining wall area is open and unrestricted.
  - In the case of balconies, at least 20% of the total wall area shall be and remain open and unrestricted.

*The following diagrams are examples of outdoor areas.  
These same principles apply to any other shaped area.*

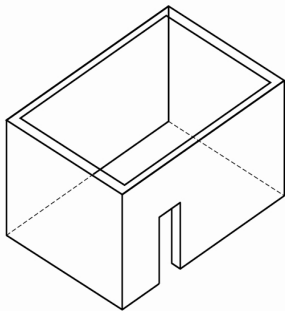

FIGURE E1—OUTDOOR AREA—EXAMPLE 1

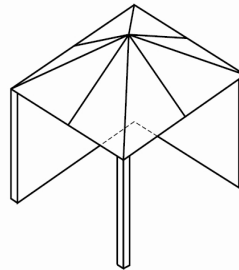
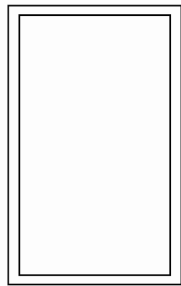

FIGURE E2—OUTDOOR AREA—EXAMPLE 2

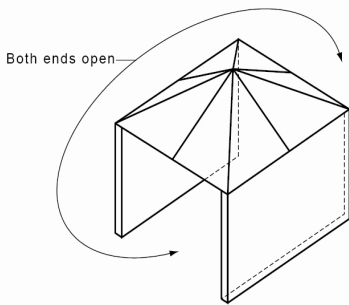
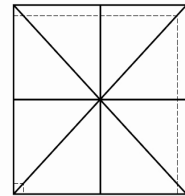
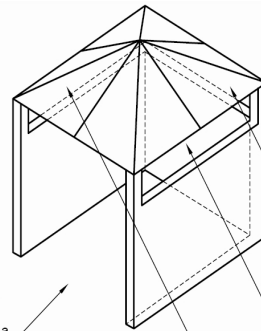
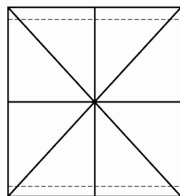
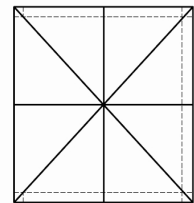

FIGURE E3—OUTDOOR AREA—EXAMPLE 3



Open side at least 25% of total wall area



30 percent or more in total of the remaining wall area is open and unrestricted

FIGURE E4—OUTDOOR AREA—EXAMPLE 4

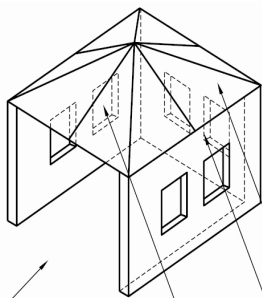

Open side at least 25% of total wall area

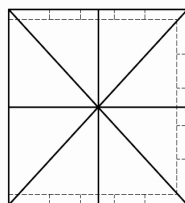

30 percent or more in total of the remaining wall area is open and unrestricted

FIGURE E5—OUTDOOR AREA—EXAMPLE 5

## FOR YOUR SAFTY

### HOSE AND REGULATOR SAFETY

- ÿ The regulator and hose assembly supplied with the heater are suitable for natural gas.
- ÿ Inspect the gas hose before each use and when replacing the gas cylinder. If the hose is cracked, cut, abraded or damaged in any way, the heater must not be operated. The hose must be replaced if damaged or when statutory conditions require it. Contact your place of purchase if uncertain.



### IMPORTANT



- ÿ **READ THIS MANUAL CAREFULLY** before installing or operating this product.
- ÿ Installation must be carried out by Authorized person in accordance with AS/NZS 5601.1:2013 (or latest edition) Gas Installation Code.
- ÿ Failure to comply with these instructions could result in a fire or explosion that could cause serious bodily injury, death or property damage.



### DANGER



- ÿ **NEVER OPERATE THE HEATER WITHOUT A REGULATOR.**
- ÿ **DO NOT ATTEMPT TO CONVERT THE LPG HEATER FOR NATURAL GAS USE. INDIVIDUAL GAS TYPES ARE FACTORY MADE.**
- ÿ **DO NOT BYPASS THE SAFETY DEVICES.**
- ÿ **FAILURE TO COMPLY WITH THESE INSTRUCTIONS COULD RESULT IN A FIRE OR EXPLOSION WHICH COULD CAUSE SERIOUS BODILY INJURY, DEATH ,OR PERPERTY DAMAGE.**

### FREE HELP

Thermofilm Australia Pty Ltd is the expert on this product and trained to help you with:

- ÿ Assembly Questions
- ÿ Heater Operation
- ÿ Replacement of Damaged or Missing parts

17 Johnston Court, Dandenong South,  
Victoria 3175, Australia

Telephone: (03) 9562 3455  
8:30am-5:00pm Mon-Fri EST

Email: [info@thermofilm.com.au](mailto:info@thermofilm.com.au)



### IMPORTANT



**DO NOT PLACE ARTICLES ON OR AGAINST THIS APPLIANCE.**

**DO NOT USE OR STORE FLAMMABLE MATERIALS NEAR THIS APPLIANCE.**

**DO NOT SPRAY AEROSOLS OR FLAMMABLE MATERIALS IN THE VICINITY OF THIS APPLIANCE WHILE IS IN OPERATION.**



### DANGER



1. Do not store or use flammable liquids or vapors in the vicinity of this appliance.
2. An LPG cylinder not connected for use shall not be stored in the vicinity of this appliance.

## FOR YOUR SAFETY

### LPG CYLINDER USE AND SAFETY

- ÿ Close LPG cylinder valve whenever the heater is not in use.
- ÿ This heater is for outdoor use only. The LPG gas cylinder must be disconnected when the heater is not in use for prolonged periods. If the heater is to be stored indoors, you must remove and store the LPG gas cylinder outdoors. Store in a well ventilated area and out of reach of children,
- ÿ The heater is designed for use with a 9KG LPG cylinder. Do not connect the heater to LPG cylinder exceeding this capacity.
- ÿ The gas cylinder should be filled by a reputable gas dealer, or exchanged at a reputable cylinder exchange outlet.
- ÿ Always keep cylinder in an upright position. Always close the cylinder valve when the heater is not in use.
- ÿ Do not subject the gas cylinder to excessive heat.



**DANGER**



1. Do not store or use flammable liquids or vapors in the vicinity of this appliance.
2. An LPG cylinder not connected for use shall not be stored in the vicinity of this appliance.

### HOSE AND REGULATOR SAFETY

- ÿ The regulator and hose assembly supplied with the heater are suitable for liquefied petroleum gas.
- ÿ A gas regulator adjusted to have an outlet pressure of 2.75 kpa is supplied for connection to the LPG cylinder. The regulator and hose assembly supplied with the heater must be used. Replacement regulators and hose assemblies must be those specified by the appliance manufacturer.
- ÿ When connecting the hose and regulator assembly to the gas cylinder, take care to avoid unnecessary twisting of the flexible hose. After the assembly has been secured, turn on the gas and check for leaks by brushing a soap and water solution over all connections. The presence of bubbles will indicate a gas escape. **DO NO TEST FOR GAS ESCAPES WITH AN OPEN FLAME.**
- ÿ If you are unable to correct the leak by tightening the connections, turn off the gas and contact your place of purchase immediately.
- ÿ Always ensure the patio heater is kept away from flammable materials and the gas cylinder clear of any heat source.
- ÿ When changing over from an empty gas cylinder to a full one, make sure this procedure is carried out in a flame-free atmosphere.
- ÿ Inspect the gas hose before each use and when replacing the gas cylinder. If the hose is cracked, cut, abraded or damaged in any way, the heater must not be operated. The hose must be replaced if damaged or when statutory conditions require it. Contact your place of purchase if uncertain.
- ÿ The hose and regulator should be disconnected from the cylinder when the heater is not in use. **DO NOT DISCONNECT THE GAS HOSE FROM THE APPLIANCE.**
- ÿ The hose assembly must be replaced prior to the appliance being put into operation if there is evidence of excessive abrasion or wear, or if the hose is damaged. The replacement hose must be purchased from Thermofilm Australia Pty Ltd.

# PRODUCT OVERVIEW

## SPECIFICATION

Wall Mounted Radiant Gas Heater		
Model Type	Wall Mounted	
Model No	TGH34WN	TGH34WL
Gas Type	NG	ULPG
Gas Pressure	1.00 KPA	2.5 KPA
Gas consumption	34 Mj/h	34 Mj/h
Injector Size	1.4 mm x 4	0.86mm x 4
Hose Connection	Rp 1/2" BSPP	1/2-1/4" NPT
Net Weight	11.5 kg	
AGA Approval No.	8442 G	

## Intallation Clearances

This appliance must only be used in a well ventilated area.

The following clearance should be followed:

The heater should not be installed:

- Where heat ignition can cause damage to gas cylinders/lines
- Near other combustible materials.
- In open locations subject to rain.

Heater should be installed to allow adequate:

- Clearance around air openings to combustion chamber.
- Clearance from combustible material.
- Provisions for accessibility and clearance for combustion and ventilating air supply.

## Dimension and Clearance Detail

Before installing the wall mounted heater, make sure the wall must be capable to supporting the weight of the heater. Place the mounting bracket in position. The heater shall be firmly and securely attached to the wall.

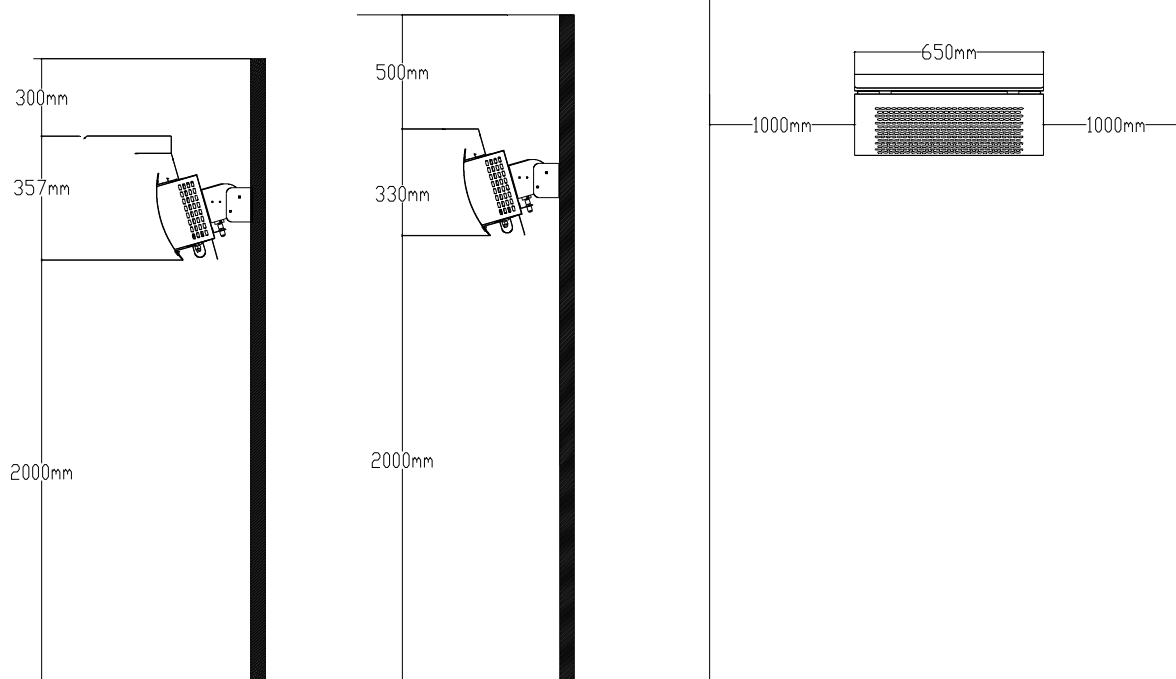

**WARNING** : MINIMUM CLEARANCES TO COMBUSTIBLE MATERIAL,  
 FROM TOP 500mm / add TGHSHIELD(not included) for 300mm,  
 SIDE 1000mm, MINIMUM MOUNTING HEIGHT 2000mm.

Note: Additional heat shield (TGHSHIELD) is required for 300mm overhead clearance and it's available at extra cost.

## Hardware Pack Parts List

PART #	PART DESCRIPTION	QTY	PURPOSE OF PART
P06033006A	Hardware Pack	1	For use in assembly of TGH42WN & TGH42WL
S112M05102	Pan Head Screw M5 x 10mm	3	Install Heat Deflector to Head
P05501166D	Pin $\Phi 6$ x 150mm	1	Install heater to Wall Mounting Bracket
P05501164B	R Cotter Pin	1	
S020100223	Bolt M6 x 150mm	1	
S411M0606A	Wing Nut M6	1	
	Screwdriver	1	

## Hardware Pack Diagram

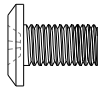

Pan Head Screw  
M5x10mm  
Qty. 3  
Part # S112M05102

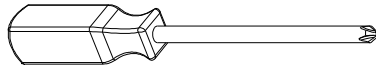

Screwdriver  
Qty. 1

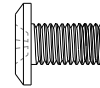

Pan Head Screw  
M6x10mm  
(Pre-Assembly)  
Qty. 2  
Part # S112M05102



Pin  $\Phi 6$  x 150mm  
Qty. 1  
Part # P05501166D



R Cotter Pin  
Qty. 1  
Part # P05501164B

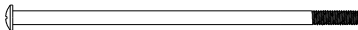

Bolt M6 x 150mm  
Qty. 1  
Part # S020100223



Wing Nut M6  
Qty. 1  
Part # S411M0606A



AA Battery

# Installation Instructions

**CAUTION:** To assemble this heater, you should obtain assistance from another person when handling the larger, heavier pieces. Please refer to the Page 6 "Dimension and Clearance Detail" before installing this heater.

## 1 Install Heat Deflector

- Remove all the packing materials.
- Install the Heat Deflector to the Head using 3 Pan Head Screws M5x10mm, then tighten all the screws securely.

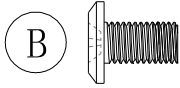

Pan Head Screw  
M5x10mm  
Qty. 3  
Part # S112M05102

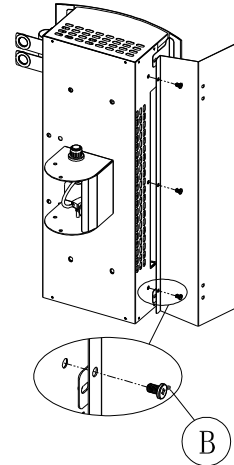

## 2 Install Battery



AA Battery

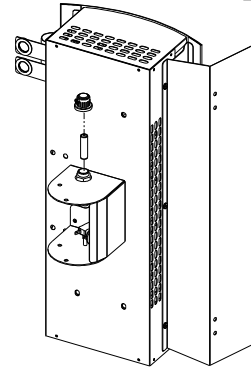

## 3 Install Regulator with hose bracket (For NG Model Only)

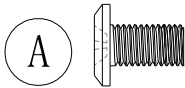

Pan Head Screw M6x10mm  
(Pre-assembly)  
Qty. 2  
Part # S112M06102

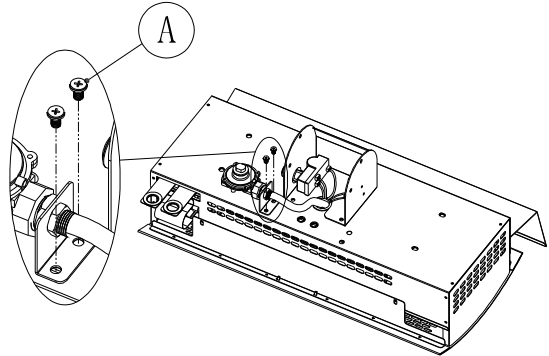

Note: Reglator with hose can be assembly at left or righth side of back panel.

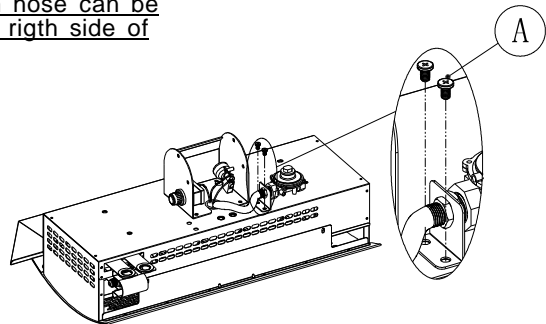

#### 4 Install Wall Mounting Bracket

- Install the wall mounting bracket to the wall with appropriate fixings for the material to be attached (Masonry, wood, metal etc.), using 6 appropriate fasteners (not included), then tighten all the screws securely.

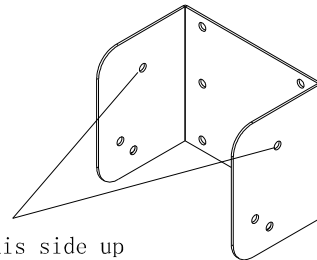

Note: This side up

#### 5 Install Heater

- Install the Heater to the Wall Mounting Bracket using 1 Pin  $\Phi 6 \times 150\text{mm}$  with 1 R Cotter Pin, using 1 Bolt  $M6 \times 150\text{mm}$  with 1 Plan Washer M6 and 1 Wing Nut M6.
- Tighten the pin and bolt securely.

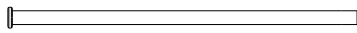

Pin  $\Phi 6 \times 150\text{mm}$   
Qty. 1  
Part # P05501166D



R Cotter Pin  
Qty. 1  
Part # P05501164B

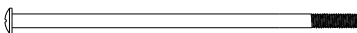

Bolt  $M6 \times 150\text{mm}$   
Qty. 1  
Part # S020100223



Wing Nut M6  
Qty. 1  
Part # S411M0606A

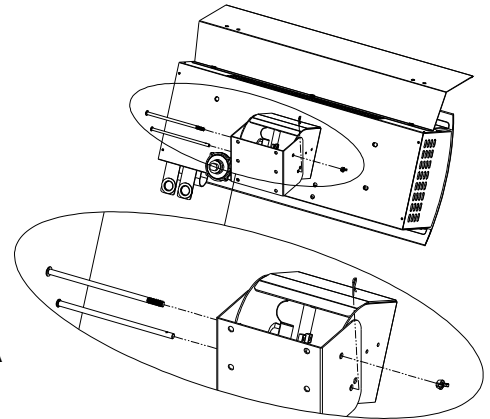

#### 6 Install Cords

- Remove the Finger Protective Rings from Trigger.
- Install Red Cord for Trigger "ON"; Black Cord For Trigger "OFF"

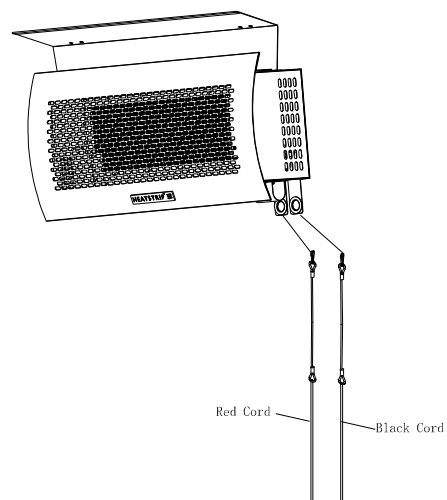

# USE AND CARE INSTRUCTIONS

## Check For Gas Leaks

**Never** test for leaks with an open flame. Prior to first use, at the beginning of each season, you must check for gas leaks. Follow these three steps:

1. Make a soap solution by mixing one part liquid detergent and four parts water.

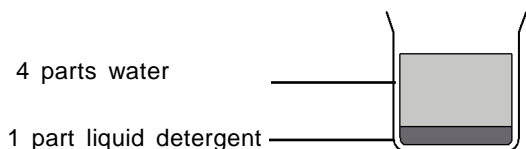

2. Pull the **black** string down until 'click' will be heard and then release, then turn on gas at source.

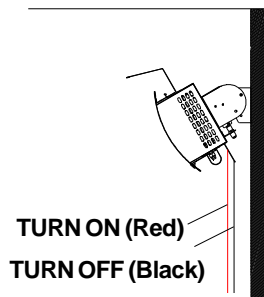

3. Apply the soap solution to all visible gas connections. If bubbles appear in the soap solution the connections are not properly sealed. Check each fitting and tighten or repair as necessary.

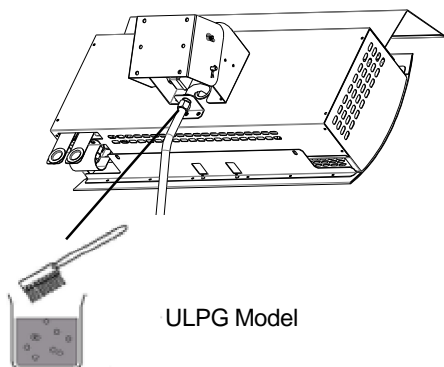
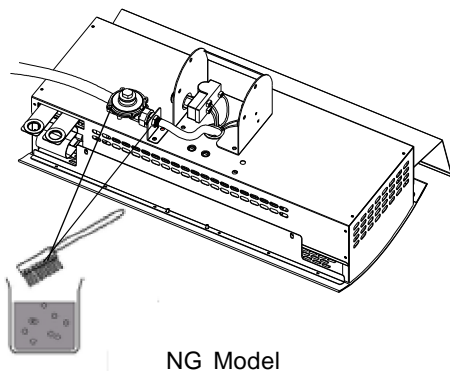

## GAS REQUIREMENTS

TGH34WN(NG)Model:

- This appliance is for use with Natural Gas only.
- Ensure that inlet pressure to the regulator does not exceed 5.0 Kpa.
- The approved inlet pressure to be 1.0 Kpa.



**Failure to read and follow the Use and Care Instructions could result in a fire or explosion that could cause serious bodily injury, death or property damage.**



If you have a gas leak that cannot be repaired by tightening, turn off the gas at the source, disconnect fuel line from your heater and call (03) 9562 3455 or your gas supplier for repair assistance.

## LIGHTING INSTRUCTIONS

### Heater Lighting Instructions

- Before each use, check all hoses for cracks, nicks, cuts, burns or abrasions. If a hose is damaged in any way, do not use your heater before replacing the hose with an authorized part from the Parts List. Also make sure all gas supply connections are securely tightened.
- Familiarize yourself with the safety and Use and Care Instructions in this Manual. Do not smoke while lighting heater or checking gas supply connections.
- Always light the heater standing to the side of the heater, never light the heater standing in front.



### WARNING



Failure to replace a faulty hose, secure gas supply connections before proceeding to the Lighting Procedures could result in a fire or explosion that could cause serious bodily injury, death, or property damage.

### TURN ON THE HEATER

1. Turn on the gas source.
2. Pull the red Cord down and 'click' will be heard and continue to hold for 10 seconds. The tiles should turn to red color. Release the string.
3. If the burner does not ignite, turn off the gas source . Wait at least 5 minutes for gas to clear, then retry. If your heater still fails to light, turn gas source OFF. Wait 5 minutes for gas to clear and then conduct a gas leak test. If no leaks are detected, repeat the lighting procedure.

### TURN OFF THE HEATER

1. Pull the Black Cord down until 'click' will be heard and then release. The tiles should turn from red to black.
2. If the heater does not turn off, repeat step one.
3. Turn off the gas supply.
4. When the heater is not in use, please turn off the gas source.

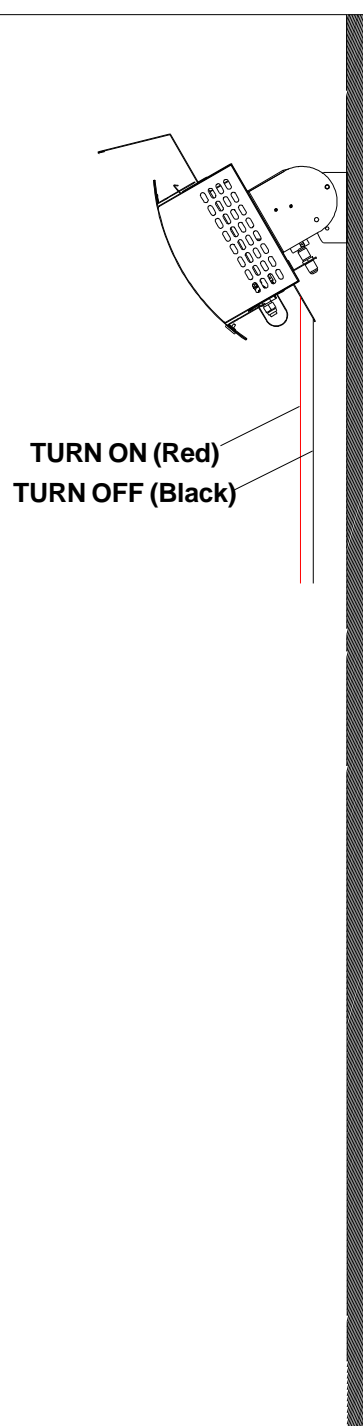

## TROUBLE SHOOTING

Fault	Causes	Remedy
Pilot or main burner will not light	(a) Air in gas line	Purge gas line
	(b) Blockage in gas line	Trace back and clear
	(c) Igniter not sparking	Repair lead, electrode, piezo or replace battery
	(d) Cylinder turned off	Turn on
	(e) Cylinder empty	Install full cylinder
Main burner will not light fully	(a) Poor gas supply	Trace supply back to source, clear where necessary
	(b) Gas control inoperative	Inspect valve, rectify
	(c) Insufficient gas	Install full cylinder/rectify gas supply
Flame is yellow	(a) Check injector	Clean if necessary
	(b) Check gas pressure	Adjust as required
	(c) Check venturi for dust	Clean if necessary
	(d) Check burner ports for blockage	Clean if necessary

WARNING

If the appliance still cannot be lit, contact (03) 9562 3455 for assistance.

## CLEANING AND MAINTENANCE

Proper care and maintenance will keep your heater in top operating condition and prolong its life. Follow these cleaning procedures on a timely basis and your heater will stay clean and operate with minimum effort.

**CAUTION:** Be sure your heater is OFF and cool before cleaning.

### ***CLEANING EXTERIOR PAINTED SURFACES***

Before initial use, and periodically thereafter, we suggest you wash your heater using a mild soap and warm water solution. You can use a wash cloth or sponge for this process.

Never use abrasive cleaners, scrubbers or stiff wire brushes of any type on your heater. These will scratch painted surfaces during the cleaning process.

Ensure the appliance is dried after cleaning to prevent rusting. It is recommended the heater be operated on high heat after cleaning to ensure the appliance is dry.

WARNING

**Failure to comply with these instructions could result in a fire or explosion that could cause serious bodily injury, death or property damage.**

Keep heater area clear and free from combustible materials, gasoline and other flammable vapors and liquids.

Keep the ventilation openings of the cylinder enclosure cabinet free and clear of debris.

## WARRANTY TERMS

Thermofilm warrants to the original owner that HEATSTRIP products will be free from defects in materials and workmanship for a period of 24 months from the date of purchase in accordance with the following warranty terms and conditions.

Provision of this warranty is subject to:

- Y The HEATSTRIP products must be installed in accordance with the Installation Instructions and relevant gas and electrical standards and codes.
- Y The HEATSTRIP products must be maintained and cleaned according to instructions detailed in the Installation Manual.
- Y There is no warranty expressed or implied with regard to capacity requirements. The selection of the unit or units depends entirely upon the system design and capacities as determined by the purchaser.
- Y The customer has not repaired, opened or altered the product in any unauthorized manner.
- Y This warranty excludes damage to the product or components arising from circumstances outside the control of Thermofilm, including, but not limited to, where the product is not used for intended purpose; where the product has been rectified in any way; incorrect installation; incorrect power supply; damaged caused during delivery; misapplication, misuse, abuse, vandalism, lack of maintenance or accident.
- Y The original invoice, including serial number are required for any claim made pursuant to the terms of warranty.
- Y Thermofilm is not liable for, and will not authorize repairs resulting from product not performing correctly as a result of being used in an environment where the ambient temperature and humidity are outside the operating conditions specified for these items.
- Y Transportation charges involved in return of the product to the Thermofilm factory (or any other location authorized in writing by Thermofilm) is the sole responsibility of the customer.
- Y The following are not covered under this warranty
  1. Breakage of the burner tiles .
  2. Rust and or discoloration due to heat or corrosive environments
  3. Damage or failure due to incorrect installation of gas supply.
  4. Any damage or loss attributable to failure to provide adequate ventilation for the product as specified by the manufacturer.
- Y Thermofilm does not participate in any site related costs or labor expenses incidental to replacement of parts, repairing, removing, installing, servicing, transportation or handling of parts to complete products, and assumes no liability on parts repaired or replaced without written authorization. Thermofilm shall not be liable for any default or delay in performance of its warranty obligations caused by any circumstances beyond its control, including, but not limited to, judicial or government restrictions, strikes, fires, floods, abnormal weather conditions, delayed supply of components.

Should products be determined as damaged on arrival, immediately notify the transport company of the condition and have them noted on the freight documents. If damage is discovered after unpacking, demand immediate inspection by the transportation company and insist that a record of the damage is made on the freight documentation.

The customer warrants using the product in accordance with:

1. Any instructions provided to it by Thermofilm from time to time.
2. All government and local regulations, including but not limited to all relevant gas electrical, environmental laws and regulations governing the installation, storage, use, handling and maintenance of the goods.
3. All necessary and appropriate precautions and safety measures relating to the installation, storage, use, handling and maintenance of goods.

*Our goods come with guarantees that cannot be excluded under the Australian Consumer Law. You are entitled to a replacement or refund for a major failure and for compensation for any other reasonably foreseeable loss or damage. You are also entitled to have the goods repaired or replaced if the goods fail to be of acceptable quality and the failure does not amount to a major failure.*

All warranty requests for repairs or replacements must be accompanied by a complete "Warranty Claim Form" available from Thermofilm, together with proof of purchase (and where possible, photos of the installation) and the heater returned to the place of purchase.

In the event of a warranty claim, the goods need to be returned to the distributor/retailer for repair replacement.

Contact Thermofilm Australia Pty Ltd  
17 Johnston Court, Dandenong South, Victoria 3175, Australia  
Telephone: (03) 9562 3455,  
Email: [info@thermofilm.com.au](mailto:info@thermofilm.com.au)

